

**IMPORTANT INFORMATION**

<i>S.No.</i>	<i>Common Name</i>	<i>Chemical Name</i>	<i>Formulae</i>
1.	Alum	Hydrated double sulphate of potassium and aluminium	$K_2SO_4 \cdot Al_2(SO_4)_3 \cdot 24 H_2O$
2.	Alumina	Aluminium oxide	$Al_2O_3$
3.	Ammonia water	Ammonium hydroxide	$NH_4OH$
4.	Angelsite	Lead sulphate	$PbSO_4$
5.	Aqua fortis	Concentrated nitric acid	$HNO_3$
6.	Aqua regia	.....	$3HCl(Conc) + HNO_3(Conc)$
7.	Azote gas	Nitrogen	$N_2$
8.	Azurite blue	Basic copper carbonate	$2CuCO_3 \cdot Cu(OH)_2$
9.	Baking Soda	Sodium hydrogen carbonate	$NaHCO_3$
10.	Baryta	Barium Hydroxide	$Ba(OH)_2$
11.	Basic lead acetate	.....	$Pb(OH)_2 \cdot Pb(CH_3COO)_2$
12.	Bauxite	Dihydrate Aluminium oxide	$Al_2O_3 \cdot 2H_2O$
13.	Blue Vitriol	Pentahydrate of cupric sulphate	$CuSO_4 \cdot 5H_2O$
14.	Bleaching powder	Calcium oxychloride or calcium (hypochlorite) chloride	$CaOCl_2$ or $Ca(OCl)Cl$
15.	Borax	Sodium tetraborate	$Na_2B_4O_7 \cdot 10H_2O$
16.	Brimstone	Sulphur	$S$
17.	Brine or common salt or rock salt	Sodium Chloride	$NaCl$
18.	Cerussite	Lead carbonate	$PbCO_3$
19.	Chalk or limestone	Calcium Carbonate	$CaCO_3$
20.	Chile saltpetre or Caliche	Sodium nitrate	$NaNO_3$
21.	Cuprite or ruby copper	Cuprous oxide	$Cu_2O$
22.	Copper glance	Copper sulphide	$Cu_2S$
23.	Carnalite	Potassium magnesium chloride	$KCl \cdot MgCl_2 \cdot 6H_2O$
24.	Calomel	Mercurous chloride	$Hg_2Cl_2$
25.	Cane sugar or Beet sugar	Sucrose	$C_{12}H_{22}O_{11}$
26.	Calgon	Sodium hexa-metaphosphate	$Na_2[Na_4(PO_3)_6]$
27.	Caustic soda	Sodium hydroxide	$NaOH$
28.	Caustic potash	Potassium hydroxide	$KOH$
29.	Calamine	Zinc carbonate	$ZnCO_3$
30.	Corundum	Aluminium oxide	$Al_2O_3$
31.	Dead burnt gypsum	Anhydrous calcium sulphate	$CaSO_4$
32.	Diaspore	Monohydrate aluminium oxide	$Al_2O_3 \cdot H_2O$
33.	Dry ice	Solid carbon dioxide	$CO_2$ (solid)
34.	Epsom salt	Heptahydrate of magnesium sulphate	$MgSO_4 \cdot 7H_2O$
35.	Fluorspar	Calcium fluoride	$CaF_2$
36.	Galena	Lead sulphide	$PbS$
37.	Glauber's salt	Hydrated sodium sulphate	$Na_2SO_4 \cdot 10H_2O$
38.	Green Vitriol	Ferrous sulphate	$FeSO_4 \cdot 7H_2O$
39.	Gypsum	Calcium sulphate dihydrate	$CaSO_4 \cdot 2H_2O$
40.	Hydrolith	Calcium hydride	$CaH_2$
41.	Hypo	Sodium thiosulphate	$Na_2S_2O_3 \cdot 5H_2O$
42.	Iron pyrites	Iron disulphide	$FeS_2$
43.	Laughing gas	Dinitrogen oxide	$N_2O$
44.	Limonite	Hydrated ferric oxide	$Fe_2O_3 \cdot 3H_2O$
45.	Litharge	Lead monoxide	$PbO$
46.	Lime	Calcium oxide	$CaO$

47.	Lime water or slaked lime	Calcium hydroxide	$\text{Ca(OH)}_2$
48.	Lime stone or chalk or marble	Calcium carbonate	$\text{CaCO}_3$
49.	Lunar caustic	Silver nitrate	$\text{AgNO}_3$
50.	Magnetite	Ferrosoferric oxide	$\text{Fe}_3\text{O}_4$
51.	Milk of lime	Calcium hydroxide	$\text{Ca(OH)}_2$
52.	Milk of magnesia	Magnesium hydroxide	$\text{Mg(OH)}_2$
53.	Marsh gas	Methane	$\text{CH}_4$
54.	Malachite (green)	Basic copper carbonate	$\text{CuCO}_3 \cdot \text{Cu(OH)}_2$
55.	Magnesia	Magnesium oxide	$\text{MgO}$
56.	Magnesite	Magnesium carbonate	$\text{MgCO}_3$
57.	Mohr's salt	Ferrous ammonium sulphate hexahydrate	$(\text{NH}_4)_2\text{SO}_4 \cdot \text{FeSO}_4 \cdot 6\text{H}_2\text{O}$
58.	Muriatic acid	Hydrochloric acid	$\text{HCl}$
59.	Nessler's reagent	Potassium tetra-iodomercurate	$\text{K}_2[\text{HgI}_4]$
60.	Nitre	Potassium nitrate	$\text{KNO}_3$
61.	Nitre cake	Sodium hydrogen sulphate	$\text{NaHSO}_4$
62.	Nitrolim	Calcium cyanamide plus carbon	$\text{CaCN}_2 + \text{C}$
63.	Nitrate of lime (Nitrolime)	Basic calcium nitrate	$\text{Ca(NO}_3)_2 \cdot \text{CaO}$
64.	Oil of Vitriol	Concentrated Sulphuric acid	$\text{H}_2\text{SO}_4$
65.	Oleum	Pyrosulphuric acid	$\text{H}_2\text{S}_2\text{O}_7$
66.	Pearl ash	Potassium carbonate	$\text{K}_2\text{CO}_3$
67.	Philosopher's wool	Zinc oxide	$\text{ZnO}$
68.	Phosgene	Carbonyl chloride	$\text{COCl}_2$
69.	Potash	Potassium carbonate	$\text{K}_2\text{CO}_3$
70.	Potash alum	Potassium aluminium sulphate	$\text{K}_2\text{SO}_4 \cdot \text{Al}_2(\text{SO}_4)_3 \cdot 24\text{H}_2\text{O}$
71.	Plaster of Paris	Hemihydrate of calcium sulphate	$\text{CaSO}_4 \cdot \frac{1}{2} \text{H}_2\text{O}$
72.	Pyrogallol	Benzene-1, 2, 3-triol	$\text{C}_6\text{H}_3(\text{OH})_3$
73.	Pyrolusite	Manganese dioxide	$\text{MnO}_2$
74.	Quartz or silica	Silicon dioxide	$\text{SiO}_2$
75.	Quick lime	Calcium oxide	$\text{CaO}$
76.	Quick silver	Mercury	$\text{Hg}$
77.	Red lead	Triplumbic tetroxide	$\text{Pb}_3\text{O}_4$
78.	Rock salt	Sodium chloride	$\text{NaCl}$
79.	Rough	Ferric oxide	$\text{Fe}_2\text{O}_3$
80.	Sal ammoniac	Solid ammonium chloride	$\text{NH}_4\text{Cl}$
81.	Sal volatile	Solid ammonium carbonate	$(\text{NH}_4)_2\text{CO}_3$
82.	Salt cake	Anhydrous sodium sulphate	$\text{Na}_2\text{SO}_4$
83.	Salt petre	Potassium nitrate	$\text{KNO}_3$
84.	Siderite	Ferrous carbonate	$\text{FeCO}_3$
85.	Silica	Silicon dioxide	$\text{SiO}_2$
86.	Silica gel	Hydrated silica	$\text{SiO}_2 \cdot x\text{H}_2\text{O}$
87.	Slaked lime	Calcium hydroxide	$\text{Ca(OH)}_2$
88.	Soda ash	Anhydrous sodium carbonate	$\text{Na}_2\text{CO}_3$
89.	Water glass	Sodium dioxide containing excess of silica	$\text{Na}_2\text{SiO}_3 \cdot \text{SiO}_2$
90.	Super phosphate of lime	Mixture of calcium dihydrogen phosphate and calcium sulphate	$\text{Ca(H}_2\text{PO}_4)_2 \cdot \text{H}_2\text{O} + 2\text{CaSO}_4 \cdot 2\text{H}_2\text{O}$
91.	Verdigris	Basic copper acetate	$\text{Cu(CH}_3\text{COO)}_2$
92.	White lead	Basic lead carbonate	$2\text{PbCO}_3 \cdot \text{Pb(OH)}_2$
93.	White Vitriol	Heptahydrate of zinc sulphate	$\text{ZnSO}_4 \cdot 7\text{H}_2\text{O}$
94.	Washing soda	Hydrated sodium carbonate	$\text{Na}_2\text{CO}_3 \cdot 10\text{H}_2\text{O}$
95.	Zincite	Zinc oxide	$\text{ZnO}$
96.	Zinc blende	Zinc sulphide	$\text{ZnS}$

**VALENCY OF SOME COMMON BASIC AND ACIDIC RADICALS**

**Electrovalent positive ions (basic radicals)**

<b>Monovalent</b>		<b>Divalent</b>		<b>Trivalent</b>	
1. Ammonium	$\text{NH}_4^+$	1. Argentic [Silver(II)]	$\text{Ag}^{2+}$	1. Aluminium	$\text{Al}^{3+}$
2. Aurous [Gold (I)]	$\text{Au}^+$	2. Barium	$\text{Ba}^{2+}$	2. Ferric [Iron (III)]	$\text{Fe}^{3+}$
3. Cuprous [Copper (I)]	$\text{Cu}^+$	3. Calcium	$\text{Ca}^{2+}$	3. Chromium	$\text{Cr}^{3+}$
4. Hydrogen	$\text{H}^+$	4. Cupric [Copper(II)]	$\text{Cu}^{2+}$	4. Auric [Gold (III)]	$\text{Au}^{3+}$
5. Mercurous [Mercury (I)]	$\text{Hg}^+$	5. Ferrous [Iron (II)]	$\text{Fe}^{2+}$	5. Bismuth	$\text{Bi}^{3+}$
6. Potassium	$\text{K}^+$	6. Magnesium	$\text{Mg}^{2+}$	6. Arsenic	$\text{As}^{3+}$
7. Sodium	$\text{Na}^+$	7. Mercuric [Mercury (II)]	$\text{Hg}^{2+}$		
8. Argentous [Silver (I)]	$\text{Ag}^+$	8. Plumbous [Lead (II)]	$\text{Pb}^{2+}$	<b>Tetravalent</b>	
9. Lithium	$\text{Li}^+$	9. Stannous [Tin (II)]	$\text{Sn}^{2+}$	1. Plumbic [Lead (IV)]	$\text{Pb}^{4+}$
		10. Zinc	$\text{Zn}^{2+}$	2. Stannic [Tin (IV)]	$\text{Sn}^{4+}$
		11. Platinous [Platinum (II)]	$\text{Pt}^{2+}$	3. Platinic [Platinum (IV)]	$\text{Pt}^{4+}$
		12. Nickel	$\text{Ni}^{2+}$		

**ELECTROVALENT NEGATIVE IONS (ACIDIC RADICALS)**

<b>Monovalent</b>		<b>Divalent</b>		<b>Trivalent</b>	
1. Acetate	$\text{CH}_3\text{COO}^-$	1. Carbonate	$\text{CO}_3^{2-}$	1. Arsenate	$\text{AsO}_4^{3-}$
2. Bicarbonate or Hydrogen carbonate	$\text{HCO}_3^-$	2. Dichromate	$\text{Cr}_2\text{O}_7^{2-}$	2. Nitride	$\text{N}^{3-}$
3. Bisulphide or Hydrogen sulphide	$\text{HS}^-$	3. Oxide	$\text{O}^{2-}$	3. Arsenite	$\text{AsO}_3^{3-}$
4. Bisulphate or Hydrogen sulphate	$\text{HSO}_4^-$	4. Peroxide	$\text{O}_2^{2-}$	4. Phosphide	$\text{P}^{3-}$
5. Bisulphite or Hydrogen sulphite	$\text{HSO}_3^-$	5. Sulphate	$\text{SO}_4^{2-}$	5. Phosphite	$\text{PO}_3^{3-}$
6. Bromide	$\text{Br}^-$	6. Sulphite	$\text{SO}_3^{2-}$	6. Phosphate	$\text{PO}_4^{3-}$
7. Chloride	$\text{Cl}^-$	7. Sulphide	$\text{S}^{2-}$	7. Borate	$\text{BO}_3^{3-}$
8. Permanganate	$\text{MnO}_4^-$	8. Silicate	$\text{SiO}_3^{2-}$	8. Aluminate	$\text{AlO}_3^{3-}$
9. Fluoride	$\text{F}^-$	9. Thiosulphate	$\text{S}_2\text{O}_3^{2-}$	<b>Tetravalent</b>	
10. Hydride	$\text{H}^-$	10. Zincate	$\text{ZnO}_2^{2-}$	1. Carbide	$\text{C}^{4-}$
11. Hydroxide	$\text{OH}^-$	11. Plumbite	$\text{PbO}_2^{2-}$	2. Ferrocyanide	$\text{Fe}(\text{CN})_6^{4-}$
12. Iodide	$\text{I}^-$	12. Stannate	$\text{SnO}_3^{2-}$		
13. Cyanide	$\text{CN}^-$	13. Manganate	$\text{MnO}_4^{2-}$		
14. Nitrate	$\text{NO}_3^-$	14. Chromate	$\text{CrO}_4^{2-}$		
15. Nitrite	$\text{NO}_2^-$	15. Oxalate	$(\text{COO})_2^{2-}$		
16. Chlorite	$\text{ClO}_2^-$				
17. Hypochlorite	$\text{ClO}^-$				
18. Chlorate	$\text{ClO}_3^-$				
19. Perchlorate	$\text{ClO}_4^-$				
20. Meta aluminate	$\text{AlO}_2^-$				

# STRUCTURE OF ATOM

## 1. INTRODUCTION

In this chapter, we explore the inside world of atoms which is full of mystery and surprises. Whole chemistry is based on atoms and their structures. We will also study the behaviour exhibited by the electrons and their consequences.

### 1.1 Discovery of fundamental particles

Dalton's atomic theory was able to explain the law of conservation of mass, law of constant composition and law of multiple proportion very successfully but it failed to explain the results of many experiments like it was known that substances like glass or ebonite when rubbed with silk or fur generate electricity

#### 1.1.1 Discovery of electron

William Crookes in 1879 studied the electrical discharge in partially evacuated tubes known as **cathode ray discharge tubes**.

A discharge tube is made of glass, about 60cm long containing two thin pieces of metals called electrodes, sealed in it. This is known as Crooke's tube. The negative electrode is known as **cathode** and positive electrode is known as **anode**.

When a gas enclosed at low pressure ( $\sim 10^{-4}$  atm) in discharge tube is subjected to a high voltage ( $\sim 10,000$ V), invisible rays originating from the cathode and producing a greenish glow behind the perforated anode on the glass wall coated with phosphorescent material ZnS is observed. These rays were called **cathode rays**.

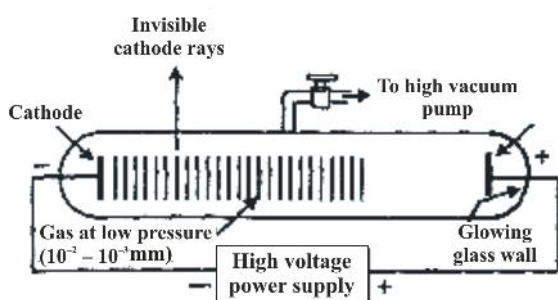

#### 1.1.2 Properties

1. They produce sharp shadow of the solid object in their path suggesting that they travel in straight line.
2. They are deflected towards the positive plate in an electric field suggesting that they are negatively charged. They were named as electrons by Stoney.

3. They can make a light paddle wheel to rotate placed in their path. This means they possess kinetic energy and are material particles.
4. They have a charge to mass ratio =  $1.75882 \times 10^{11}$ C/kg
5. They ionise gases through which they travel.
6. They produce X-rays when they strike a metallic target.
7. The characteristics of cathode rays (electrons) do not depend on the material of electrodes and nature of the gas present in the cathode ray tube.

Thus, we can conclude that electrons are basic constituents of all matter.

#### 1.1.3 Charge to mass ratio of electron

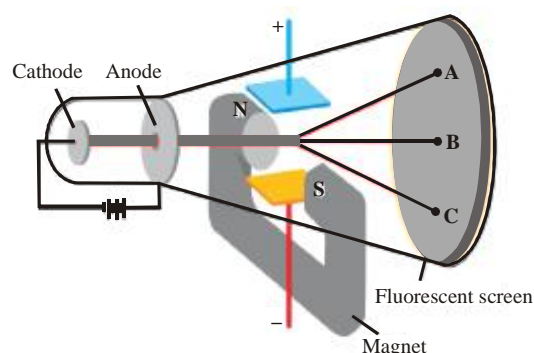

In 1897 J.J. Thomson measured  $e/m$  ratio of electron by using cathode ray tube and applying electric and magnetic field perpendicular to each other as well as to the path of electrons. The extent of deviation of electrons from their path in the presence of electric and magnetic field depends on:

- (a) Charge on the electron
- (b) Mass of the particle
- (c) The strength of electric or magnetic field

When only electric field is applied, the electrons are deflected to the point A. When only magnetic field is applied the electrons are deflected to the point C. By balancing the strengths of electric or magnetic fields, the electrons are allowed to hit the screen at point B i.e. the point where electrons hit in the absence of electric and magnetic field. By measuring the amount of deflections Thomson was able to calculate the value of  $e/m$  as  $1.758820 \times 10^{11}$ C/kg.

## STRUCTURE OF ATOM

### 1.1.4 Charge on the electron

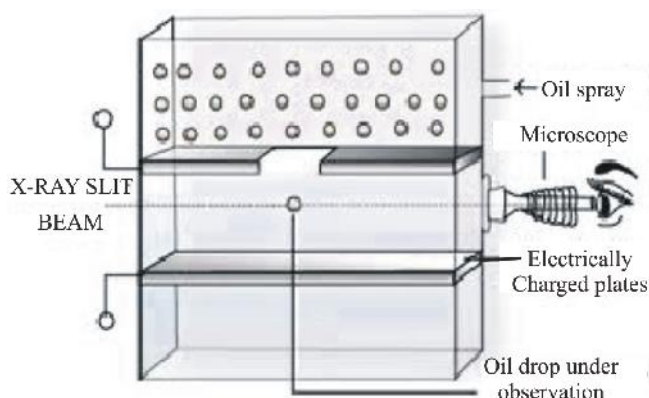

R.A Millikan devised a method known as oil drop experiment to determine the charge on the electrons.

In this method, oil droplets in the form of mist, produced by the atomiser, were allowed to enter through a tiny hole in the upper plate of electrical condenser. The downward motion of these droplets was viewed through the telescope, equipped with a micrometer eye piece. By measuring the rate of fall of these droplets, Millikan was able to measure the mass of oil droplets. The air inside the chamber was ionized by passing a beam of X-rays through it. The electrical charge on these oil droplets was acquired by collisions with gaseous ions. The fall of these charged oil droplets can be retarded, accelerated or made stationary depending upon the charge on the droplets and the polarity and strength of the voltage applied to the plate. By carefully measuring the effects of electrical field strength on the motion of oil droplets, Millikan concluded that the magnitude of electrical charge,  $q$ , on the droplets is always an integral multiple of the electrical charge  $e$ , that is,  $q = n e$ , where  $n = 1, 2, 3, \dots$

Charge on the electron is found to be  $-1.6022 \times 10^{-19} \text{C}$ .

The mass of electron was thus calculated as

$$m = \frac{e}{e/m} = \frac{1.6022 \times 10^{-19} \text{C}}{1.758820 \times 10^{11} \text{C/kg}} = 9.1094 \times 10^{-31} \text{kg}.$$

### 1.1.5 Origin of cathode rays

The cathode rays are first produced from the material of the cathode and then from the gas inside the discharge tube due to bombardment of the gas molecules by the high speed electrons emitted first from the cathode.

### 1.2.1 Discovery of proton

Since the atom as a whole is electrically neutral and the presence of negatively charged particles in it was

established, therefore it was thought that some positively charged particles must also be present in the atom. So, during the experiments with cathode rays, the scientist Goldstein designed a special type of discharge tube. He discovered new rays called **Canal rays**. The name canal rays is derived from the fact that the rays travelled in straight line through a vacuum tube in the opposite direction to cathode rays, pass through and emerge from a canal or hole in the cathode. They are also known as **anode rays**.

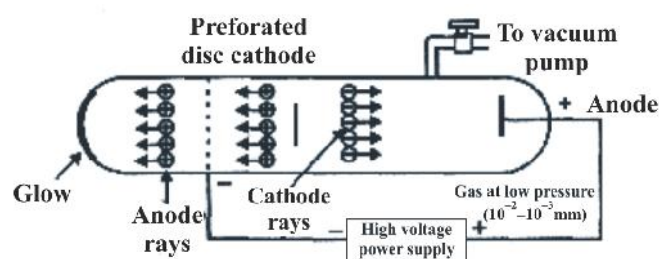

### 1.2.2 Properties:

1. They travel in straight lines.
2. They carry a positive charge.
3. They are made up of material particles.
4. The value of the charge on the particles constituting the anode rays is found to depend on the nature of gas taken.
5. The mass of the particles constituting the anode rays is found to depend on the nature of gas taken.
6. The charge to mass ratio( $e/m$ ) of the particles is also found to depend on the gas taken.
7. Their behaviour in electric and magnetic field is opposite to that observed for electron.

### 1.2.3 Origin of anode rays:

These rays are believed to be produced as a result of the knock out of the electrons from the gaseous atoms by the bombardment of high speed electrons of the cathode rays on them. These anode rays are not emitted from the anode but are produced in the space between the anode and the cathode.

The lightest charged particles were obtained when the gas taken in the discharge tube was hydrogen. The  $e/m$  value of these particles were maximum. They had minimum mass and unit positive charge. The particle was called a proton.

Charge on a proton =  $+ 1.6022 \times 10^{-19} \text{C}$

Mass of a proton =  $1.672 \times 10^{-27}$ kg

### 1.3.1 Discovery of neutron

The theoretical requirement for the existence of a neutron particle in the atomic nucleus was put forward by Rutherford in 1920. It was proposed to be a particle with no charge and having mass almost equal to that of a proton. He named it

as neutron. In 1932 Chadwick proved its existence. He observed that, when a beam of  $\alpha$  particles ( ${}^4_2\text{He}$ ) is incident on Beryllium (Be), a new type of particle was ejected. It had mass almost equal to that of a **proton** ( $1.674 \times 10^{-27}$ kg) and carried no charge.

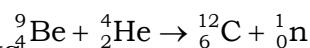
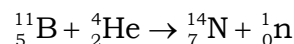

### SUMMARY :

## ATOMIC BUILDING BLOCKS

Name	Discoverer	Symbol	Charge	Relative Charge	Mass
Electron	J.J. Thomson	e	$-1.6022 \times 10^{-19}$ C	-1	$9.1094 \times 10^{-31}$ Kg
Proton	Goldstein	p	$+1.6022 \times 10^{-19}$ C	+1	$1.6726 \times 10^{-27}$ kg
Neutron	Chadwick	n	0	0	$1.6749 \times 10^{-27}$ kg

## 2. DEFINITIONS

### 2.1 Electron

A fundamental particle which carries one unit negative charge and has a mass nearly equal to  $1/1837^{\text{th}}$  of that of hydrogen atom.

### 2.2 Proton

A fundamental particle which carries one unit positive charge and has a mass nearly equal to that of hydrogen atom.

### 2.3 Neutron

A fundamental particle which carries no charge but has a mass nearly equal to that of hydrogen atom.

## 3. THOMSON MODEL

Sir J. J. Thomson, who discovered the electron, was the first to suggest a model of atomic structure.

- (i) All atoms contain electrons.
- (ii) The atom as a whole is neutral. The total positive charge and total negative charge must be equal.

He visualised all the positive charge of the atom as being spread out uniformly throughout a sphere of atomic dimensions (i.e. approx.  $10^{-10}$  m in diameter). The electrons

were smaller particles together carrying a negative charge, equal to the positive charge in the atom. They were studied in the atom like plums in a pudding. The charge distribution was such, that it gave the most stable arrangement. This model of the atom was often called the plum – pudding model. Also the raisin pudding model or watermelon model.

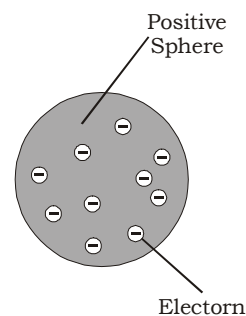

Thomson's proposed model of atom.

### 3.1 Drawbacks

Though the model was able to explain the overall neutrality of the atom, it could not satisfactorily explain the results of scattering experiments carried out by Rutherford.

## 4. RUTHERFORD'S $\alpha$ -SCATTERING EXPERIMENT

Rutherford conducted  $\alpha$ - particles scattering experiments in 1909. In this experiment, a very thin foil of gold (0.004nm) is bombarded by a fine stream of alpha particles. A fluorescent screen (ZnS) is placed behind the gold foil, where

## STRUCTURE OF ATOM

points were recorded which were emerging from  $\alpha$ -particles. Polonium was used as the source of  $\alpha$ -particles.

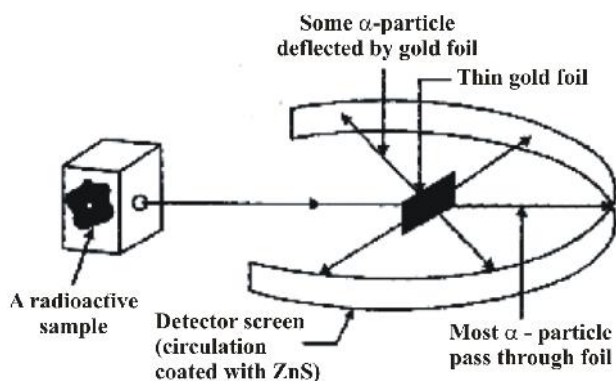

RUTHERFORD'S SCATTERING EXPERIMENT

### 4.1 Observations

Rutherford carried out a number of experiments, involving  $\alpha$ -particles by a very thin foil of gold. Observations were:

- (i) Most of the  $\alpha$ -particles (99%) pass through it, without any deviation or deflection.
- (ii) Some of the  $\alpha$ -particles were deflected through small angles.
- (iii) Very few  $\alpha$ -particles were deflected by large angles and occasionally an  $\alpha$ -particle got deflected by  $180^\circ$ .

### 4.2 Conclusions

- (i) An atom must be extremely hollow and must consist of mostly empty space because most of the particles passed through it without any deflection.
- (ii) Very few particles were deflected to a large extent. This indicates that:
  - (a) Electrons because of their negative charge and very low mass cannot deflect heavy and positively charged  $\alpha$  particles
  - (b) There must be a very heavy and positively charged body in the atom i.e. nucleus which does not permit the passage of positively charged  $\alpha$  particles.
  - (c) Because, the number of  $\alpha$  particles which undergo deflection of  $180^\circ$ , is very small, therefore the volume of positively charged body must be extremely small fraction of the total volume of the atom. This positively charged body must be at the centre of the atom which is called **nucleus**.

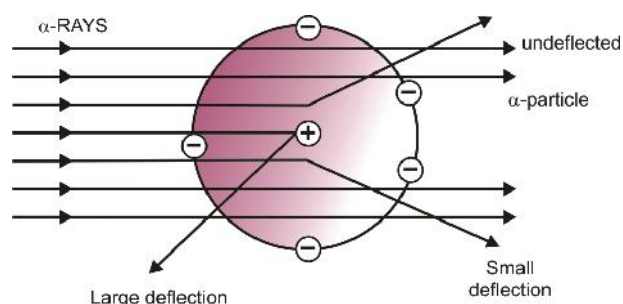

It has been found that radius of atom is of the order of  $10^{-10}\text{m}$  while the radius of the nucleus is of the order of  $10^{-15}\text{m}$ .

Thus if a cricket ball represents a nucleus, then the radius of atom would be about 5 km.

### 4.3 Rutherford's nuclear atomic model

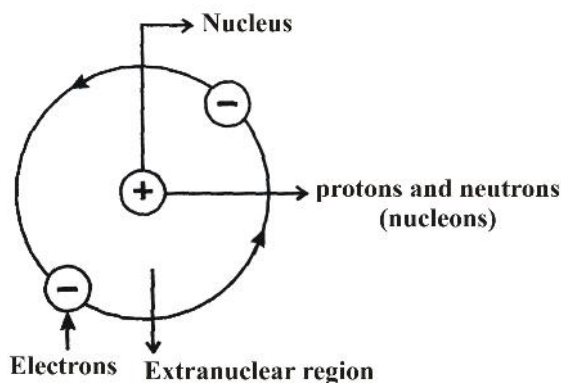

- (i) An atom consists of tiny positively charged nucleus at the centre and it is surrounded by hollow portion called extra nuclear part.
- (ii) The positive charge of the nucleus is due to **nucleons** which consist of protons and neutrons while the electrons, present in extra nuclear portion has negligible mass and carry a negative charge.
- (iii) The atom is electrically neutral, as the number of electrons is equal to number of protons in it. Thus, total positive charge of the nucleus is balanced by the total negative charge of electrons.
- (iv) The electrons in the extra nuclear part are revolving around the nucleus in circular paths called **orbits**. Thus, an atom resembles the solar system in which the sun plays the role of nucleus and the planets that of revolving electrons and the model is known as **planetary model**.
- (v) Electrons and nucleus are held together by the electrostatic force of attraction.

- (vi) Forces of attraction operating on the electron are exactly balanced by centrifugal forces.

#### 4.4 Drawbacks

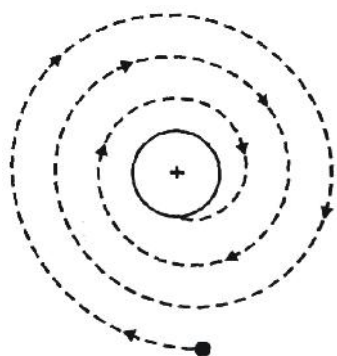

ELECTRON FALLING INTO THE NUCLEUS

- (i) According to classical mechanics, any charged body in motion under the influence of attractive forces should radiate energy continuously. If this is so, the electron will follow a spiral path and finally fall into the nucleus and the structure would collapse. This behaviour is never observed.
- (ii) It says nothing about the electronic structure of atoms i.e. how the electrons are distributed around the nucleus and what are the energies of these electrons.

### 5. ATOMIC NUMBER AND MASS NUMBER

#### 5.1 Atomic number (Z)

Atomic number of an element is equal to the number of unit positive charges or number of protons present in the nucleus of the atom of the element. It also represents the number of electrons in the neutral atom. Eg. Number of protons in Na = 11, thus atomic number of Na=11

#### 5.2 Mass number (A)

The elementary particles (protons and neutrons) present in the nucleus of an atom are collectively known as nucleons. The mass number (A) of an atom is equal to the sum of protons and neutrons. It is always a whole number. Thus, Mass number (A) = Number of protons(Z) + Number of neutrons(n)

Therefore, **number of neutrons (n) = Mass Number (A) – Number of protons (Z)**

$$n = A - Z$$

*Note.* 

The general notation that is used to represent the mass number and atomic number of a given atoms is  ${}^A_ZX$

Where, X – symbol of element

A – Mass number

Z – atomic number

#### 5.3 Isotopes, Isobars, isotones and Iseolectronic

##### 5.3.1 Isotopes:

Isotopes are the atoms of the same element having identical atomic number but different mass number. The difference is due to the difference in number of neutrons.

The chemical properties of atoms are controlled by the number of electrons. Thus, isotopes of an element show same chemical behaviour.

##### Isotopes of Hydrogen

Isotope	Formula	Mass number	No. of protons	No. of neutrons
Protium	${}^1_1\text{H}$ (H)	1	1	0
Deuterium	${}^2_1\text{H}$ (D)	2	1	1
Tritium	${}^3_1\text{H}$ (T)	3	1	2

##### Isotopes of Oxygen

Isotope number	Mass number	No. of protons	No. of neutrons
${}^{16}_8\text{O}$	16	8	8
${}^{17}_8\text{O}$	17	8	9
${}^{18}_8\text{O}$	18	8	10



## STRUCTURE OF ATOM

### Isotopes of some common elements

Element	Isotopes
Carbon (C)	${}^1_6\text{C}$ , ${}^{13}_6\text{C}$ , ${}^{14}_6\text{C}$
Nitrogen (N)	${}^{14}_7\text{N}$ , ${}^{15}_7\text{N}$
Uranium	${}^{233}_{92}\text{U}$ , ${}^{235}_{92}\text{U}$ , ${}^{238}_{92}\text{U}$
Sulphur	${}^{32}_{16}\text{S}$ , ${}^{33}_{16}\text{S}$ , ${}^{34}_{16}\text{S}$ , ${}^{36}_{16}\text{S}$

### 5.3.2 Relative Abundance:

Isotopes of an element occur in different percentages in nature, which is termed as relative abundance.

Using this relative abundance the average atomic mass of the element can be calculated. For Example,

the average atomic mass of Cl is 35.5 due to existence of two isotopes  ${}^{35}\text{Cl}$  and  ${}^{37}\text{Cl}$  in 75% and 25% abundance respectively

### 5.3.3 Isobars:

Atoms of different elements having different atomic numbers but same mass numbers are called isobars. Eg

Isobar	Atomic number	Mass number	No. of electrons	No. of protons	No. of neutrons
${}^{40}_{18}\text{Ar}$	18	40	18	18	22
${}^{40}_{19}\text{K}$	19	40	19	19	21
${}^{40}_{20}\text{Ca}$	20	40	20	20	20

### 5.3.4 Isotones:

Atoms of different elements which contain the same number of neutrons are called isotones. Eg

Isotones	Atomic	Mass number	No. of neutros
${}^{36}_{16}\text{S}$	16	36	20
${}^{37}_{17}\text{Cl}$	17	37	20
${}^{38}_{18}\text{Ar}$	18	38	20
${}^{39}_{19}\text{K}$	19	39	20
${}^{40}_{20}\text{Ca}$	20	40	20

### 5.3.5 Isoelectronic:

The species (atoms or ions) containing the same number of electrons are called isoelectronic. Eg.

$\text{O}^{2-}$ ,  $\text{F}^-$ ,  $\text{Na}^+$ ,  $\text{Mg}^{+2}$ ,  $\text{Al}^{+3}$ , Ne etc

To go further into the atomic mysteries, we will have to understand the nature of electromagnetic radiations and study **Maxwell's Electromagnetic Wave theory**".

James Maxwell was the first to give a comprehensive explanation about the interaction between the charged bodies and the behaviour of electric and magnetic fields.

## 6. ELECTROMAGNETIC RADIATIONS

Electromagnetic Radiations are waves which are formed as a result of oscillating magnetic and electric fields which are perpendicular to each other and both are perpendicular to direction of motion.

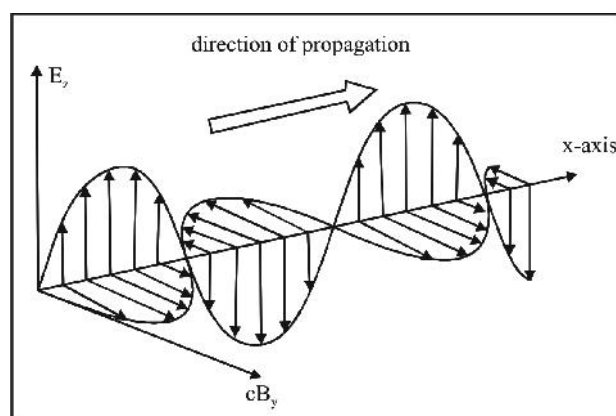

They do not require any medium and can move in vacuum unlike sound waves.

Light is a form of radiation and has wave characteristics. The various characteristics of a wave are:

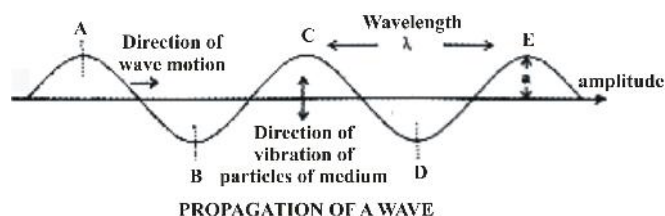

- Amplitude** : It is height of the crest or trough (depth) of a wave. Units : metre (m)
- Frequency (€)** : The number of waves passing through a point in one second. **Units** : Hertz (Hz) or  $\text{s}^{-1}$
- Time Period** : The time taken by a wave to complete one vibration is called time period. **Units** : sec

4) **Velocity** : The distance travelled by a wave in one second is called velocity. **Units** : m/s

In vacuum, all types of electromagnetic radiations travel at the same speed i.e.  $3 \times 10^8$  m/s. This is called speed of light.

5) **Wavelength** (  $\lambda$  ) : The distance between two adjacent crests or troughs is called wavelength. **Units** : Angstrom( $\text{\AA}$ )  
[1  $\text{\AA}$ = $10^{-10}$ m]

6) **Wave Number** ( $\bar{\nu}$ ) : It is the number of wavelengths per centimetre of length. **Units** :  $\text{m}^{-1}$

$$\bar{\nu} = 1/\lambda$$

### 6.1 Relationship between velocity, frequency & wavelength

$$c = \nu\lambda$$

where **c** : speed of light i.e.  $3 \times 10^8$  m/s in vacuum

**v** : frequency;  $\lambda$ : wavelength

## 7. ELECTROMAGNETIC SPECTRUM

When all the electromagnetic radiations are arranged in increasing order of wavelength or decreasing frequency the band of radiations obtained is termed as electromagnetic spectrum.

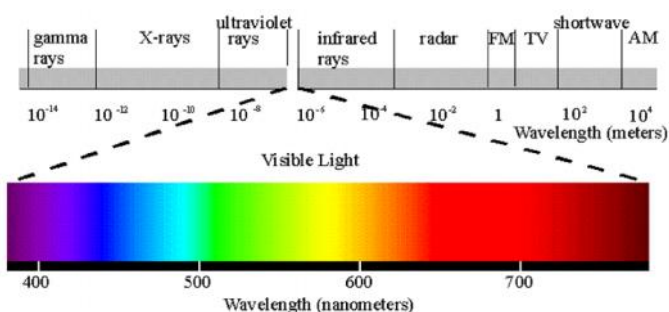

The visible spectrum is a subset of this spectrum (VIBGYOR) whose range of wavelength is 380-760nm.

The wavelengths increase in the order:

**Gamma Rays < X-rays < Ultra-violet rays < Visible < Infrared < Micro-waves < Radio waves.**

### 7.1 Electromagnetic Wave Theory

The main points of this theory are:

- (1) A source (like the heated rod) emits energy **continuously** in the form of radiations (i.e. no change in wavelength or frequency of the emitted radiations even on increasing the energy radiated).
- (2) These radiations are Electromagnetic in nature.

### 7.2 Failure of EM wave theory

The theory failed because of 2 experiments:

#### (1) Black Body Radiation :

According to Maxwell's theory on heating a body the intensity should increase, that is, energy radiated per unit area should increase without having any effect on the wavelength or frequency.

But we observe that when we heat an iron rod, it first turns to red then white and then becomes blue at very high temperatures. This means that frequency of emitted radiations is changing.

An ideal body, which emits and absorbs radiations of all frequencies is called **black body** and radiation emitted by a black body is called **black body radiation**

The variation of intensity with wavelength at different temperatures for a black body is shown below:

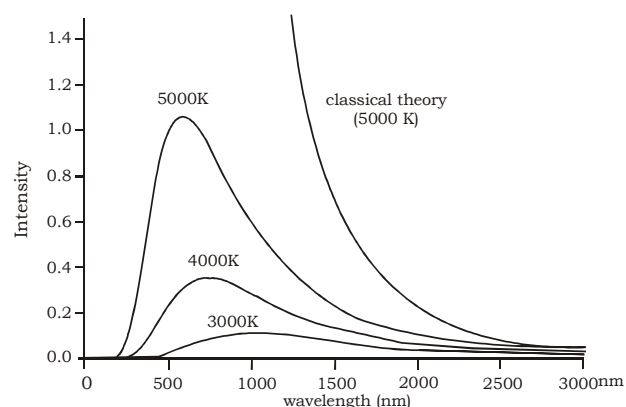

So it is observed that with increasing temperature the dominant wavelength in the emitted radiations decreases and the frequency increases.

That is at higher temperatures, though the intensity rises as predicted by Maxwell's theory but the wavelength decreases. If  $T_1 > T_2 > T_3$  then  $\lambda_1 < \lambda_2 < \lambda_3$ .

#### (2) Photoelectric Effect

When radiations with certain minimum frequency ( $\nu_0$ ) strike the surface of a metal, the electrons are ejected from the surface of the metal. This phenomena is called **photoelectric effect**. The electrons emitted are called **photoelectrons**.

## STRUCTURE OF ATOM

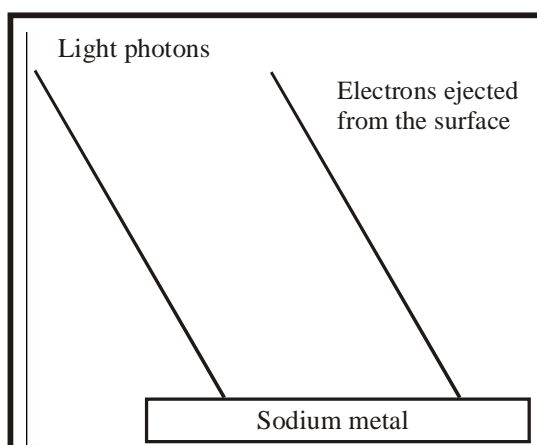

According to Maxwell's Theory the ejection of electrons should depend on intensity of radiation that is if electrons are not being ejected, then on increasing the intensity they can be ejected.

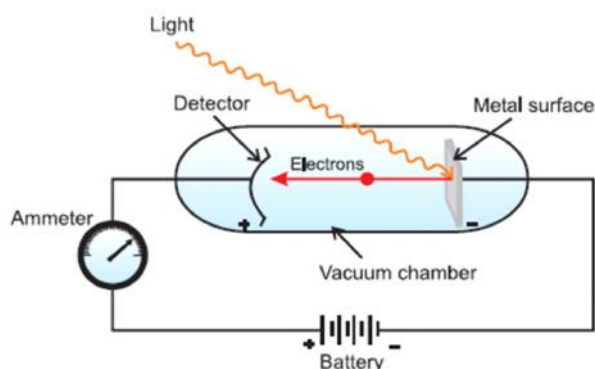

The following **observations** are made:

- The electrons are ejected from the metal surface as soon as the beam of light strikes the surface, i.e., there is no time lag between the striking of light beam and the ejection of electrons from the metal surface.
- The number of electrons ejected is proportional to the intensity or brightness of light.
- For each metal, there is a characteristic minimum frequency,  $\nu_0$  (also known as **threshold frequency**) below which photoelectric effect is not observed. At a frequency  $\nu > \nu_0$ , the ejected electrons come out with certain kinetic energy. The kinetic energies of these electrons increase with the increase of frequency of the light used.

Thus, these findings were contradictory to the Maxwell's theory. The number of electrons ejected and kinetic energy associated with them should depend on the intensity of light. It has been observed that though the number of electrons ejected does depend upon the brightness of light, the kinetic energy of the ejected electrons does not.

To justify these findings Max Von Planck gave his Quantum theory.

## 8. PLANCK'S QUANTUM THEORY

The main points of this theory are:

- The energy is emitted or absorbed not continuously but **discontinuously** in the form of small discrete packets of energy. Each such packet of energy is called a '**quantum**'. In case of light this quantum of energy is called a **photon**.

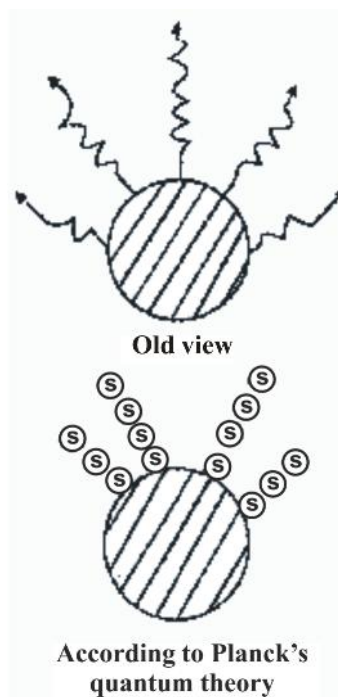

- At a time only one photon can be supplied to one electron or any other particle.
- One quantum cannot be divided or distributed.
- The energy of each quantum is directly proportional to the frequency of radiation.

$$E \propto \nu \text{ or } E = h\nu = \frac{hc}{\lambda}$$

$h$  = Planck's constant =  $6.626 \times 10^{-34}$  Js

- The total energy emitted or absorbed by a body will be in whole number quanta.

$$\text{Hence } \mathbf{E} = nh\nu = \frac{nhc}{\lambda}$$

This is also called "**Quantisation of energy**".

**8.1 Explanation of Black body radiation**

As the temperature is increased the energy emitted increases thereby increasing the frequency of the emitted radiations. As the frequency increases the wavelength shifts to lower values.

**8.2 Explanation of Photoelectric effect**

- (i) When light of some particular frequency falls on the surface of metal, the photon gives its entire energy to the electron of the metal atom. The electron will be ejected from the metal only if the energy of the photon is sufficient to overcome the force of attraction of the electron by the nucleus. So, photoelectrons are ejected only when the incident light has a certain minimum frequency (threshold frequency  $\nu_0$ ). The Threshold energy required for emission is called “**Work Function**” that is “ $h\nu_0$ ”.
- (ii) If the frequency of the incident light ( $\nu$ ) is more than the threshold frequency ( $\nu_0$ ), the excess energy is imparted to the electron as kinetic energy. Hence,

**Energy of one quantum = Threshold Energy + Kinetic Energy**

$$h\nu = h\nu_0 + (1/2) m_e v^2$$

- (iii) When  $\nu > \nu_0$ , then on increasing the intensity the number of quanta incident increases thereby increasing the number of photoelectrons ejected.
- (iv) When  $\nu > \nu_0$ , then on further increasing the frequency, the energy of each photon increases and thus kinetic energy of each ejected electron increases.

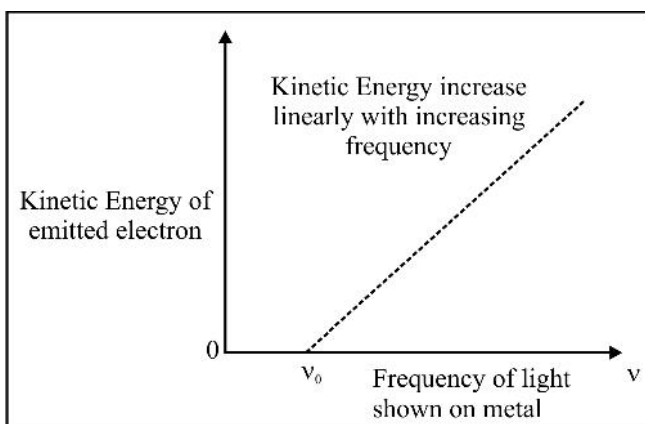

Energy can also be expressed in Electron Volt(eV).

The energy acquired by an electron when it is accelerated through a potential difference of one Volt.

$$1eV = 1.602 \times 10^{-19}J$$

**CONCLUSION:**

Light has both the **Wave nature** (shows the phenomena of diffraction and interference) **and Particle nature** (could explain the black body radiation and photoelectric effect) . Thus, light has dual nature.

Bohr’s Model is based on “Atomic Spectra”, therefore before moving further we will study:

**9. WHAT IS SPECTRUM?**

A spectrum is a group or band of wavelengths/colours and the study of emission or absorption spectra is known as spectroscopy.

**9.1 Types of spectrum**

There are two types of spectrum:

- 1) Emission Spectrum
- 2) Absorption Spectrum

**9.2 Emission Spectrum**

When radiations emitted from a source are incident on a prism and are separated into different wavelengths and obtained on a photographic plate.

(a) **Continuous Emission Spectra:**

There are no gaps between various wavelengths, one wavelength merges into another.

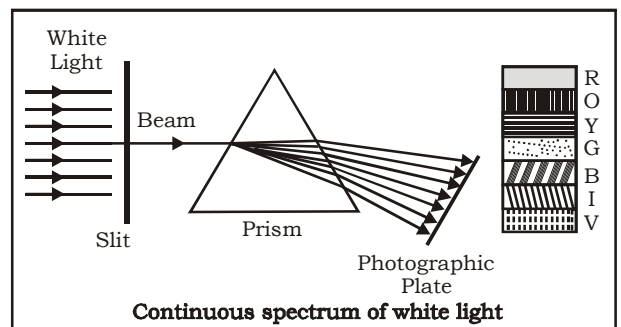

## STRUCTURE OF ATOM

### (b) Discontinuous Emission Spectra:

It is also known as **Line Spectra** or **atomic spectra**.

In this, certain wavelengths go missing from a group and that leaves dark spaces in between giving discontinuity to the spectrum. It is also known as **fingerprint of an element**.

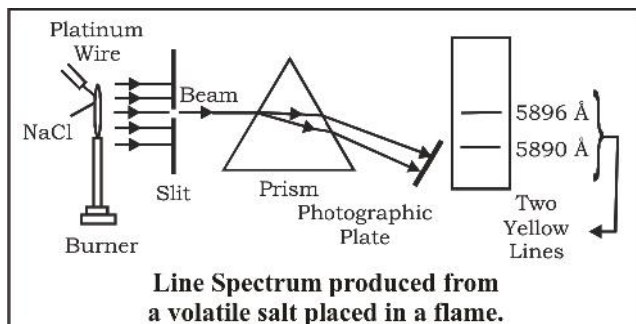

### 9.3 Absorption Spectra

When light from any source is first passed through the solution of a chemical substance and then analysed, it is observed that there are some dark lines in the otherwise continuous spectra.

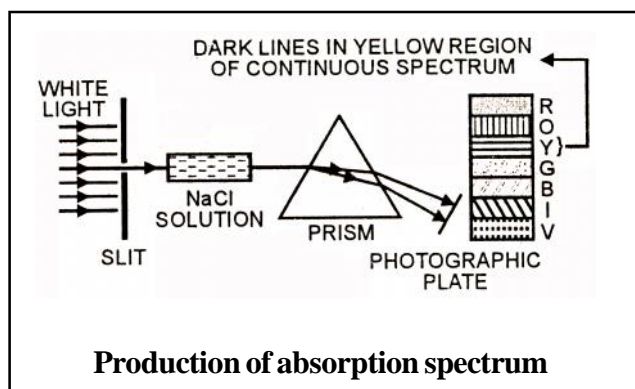

Bohr studied the atomic spectra of hydrogen and based on that he proposed his model.

## 10. BOHR'S MODEL

**Note:** This model is applicable to H-atom or H-like species like  $\text{He}^+$ ,  $\text{Li}^{2+}$ ,  $\text{Be}^{3+}$ .

### 10.1 Postulates

- An atom consists of a small, heavy, positively charged nucleus in the centre and the electrons revolve around it in circular orbits.
- Electrons revolve only in those orbits which have a fixed value of energy. Hence, these orbits are called energy levels or stationary states. They are numbered as 1,2,3,..... These numbers are known as **Principal quantum Numbers**.
  - Energy** of an electron is given by:
 
$$E_n = -R_H(Z^2/n^2) \quad n = 1,2,3,\dots$$
 where  $R_H$  is Rydberg's constant and its value is  $2.18 \times 10^{-18} \text{ J}$ .  
 $Z =$  atomic number
 
$$E_n = -2.18 \times 10^{-18} \frac{Z^2}{n^2} \text{ J/atom}$$

$$E_n = -13.6 \frac{Z^2}{n^2} \text{ eV/atom}$$

$$E_n = -1312 \frac{Z^2}{n^2} \text{ kJ/mol}$$
 Thus, energies of various levels are in the order:  $K < L < M < N, \dots$  and so on. Energy of the lowest state ( $n=1$ ) is called **ground state**.
  - Radii** of the stationary states:
 
$$r_n = \frac{52.9n^2}{Z} \text{ pm}$$
 For H-atom ( $Z = 1$ ), the radius of first stationary state is called **Bohr orbit** (52.9 pm)
  - Velocities** of the electron in different orbits:
 
$$v_n = \frac{2.188 \times 10^6 Z}{n} \text{ m/s}$$
- Since the electrons revolve only in those orbits which have fixed values of energy, hence electrons in an atom can have only certain definite values of energy and not any of their own. Thus, **energy of an electron is quantised**.
- Like energy, the angular momentum of an electron in an atom can have certain definite values and not any value of their own.

$$mvr = \frac{nh}{2\pi}$$

Where  $n=1,2,3,\dots$  and so on.

- 5) An electron does not lose or gain energy when it is present in the same shell.
- 6) When an electron gains energy, it gets excited to higher energy levels and when it de-excites, it loses energy in the form of electromagnetic radiations and comes to lower energy values.

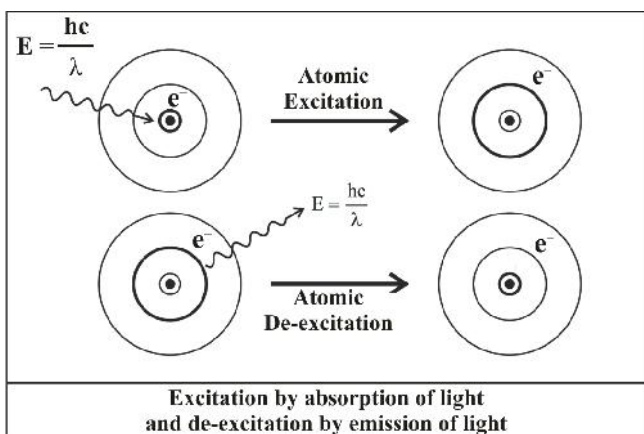

**10.2 What does negative energy for Hydrogen atom means?**

This negative sign means that the energy of the electron in the atom is lower than the energy of a free electron at rest. A free electron at rest is an electron that is infinitely far away from the nucleus ( $n = \infty$ ) and is assigned the energy value of zero. As the electron gets closer to the nucleus (as  $n$  decreases),  $E_n$  becomes more and more negative. The most negative energy value is given by  $n=1$  which corresponds to the most stable orbit.

**10.3 Transition of Electron**

We know that energy is absorbed or emitted when electron excites or de-excites respectively. The energy gap between the two orbits is

$$\Delta E = E_f - E_i$$

$$\Delta E = \left( -\frac{R_H}{n_f^2} \right) - \left( -\frac{R_H}{n_i^2} \right)$$

$$\Delta E = R_H \left( \frac{1}{n_i^2} - \frac{1}{n_f^2} \right) = 2.18 \times 10^{-18} \left( \frac{1}{n_i^2} - \frac{1}{n_f^2} \right) \text{ J/atom}$$

The wavelength associated with the absorption or emission of the photon is:

$$\frac{1}{\lambda} = \frac{\Delta E}{hc} = \frac{R_H}{hc} \left( \frac{1}{n_i^2} - \frac{1}{n_f^2} \right) = 1.09677 \times 10^7 \left( \frac{1}{n_i^2} - \frac{1}{n_f^2} \right) \text{ m}^{-1}$$

This is known as Rydberg's formula.

*Note..*

$1.09677 \times 10^7 \text{ m}^{-1}$  is also known as Rydberg's constant.

**10.4 Line Spectrum of Hydrogen**

When an electric discharge is passed through gaseous hydrogen, the  $H_2$  molecules dissociate and the energetically excited hydrogen atoms produced emit electromagnetic radiations of discrete frequency. The hydrogen spectra consists of several lines named after their discoverer.

We get discrete lines and not a continuous spectra because the energy of an electron cannot change continuously but can have only definite values. Thus we can say that energy of an electron is quantised.

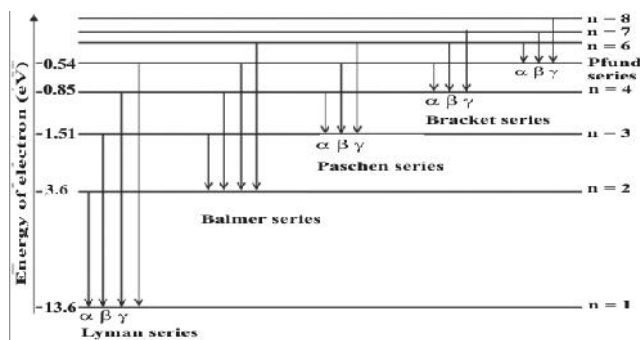

**LYMAN SERIES:**

When an electron jumps from any of the higher states to the ground state or first state ( $n = 1$ ), the series of spectral lines emitted lies in the **ultra violet** region and are called as Lyman series.

Therefore, in Rydberg's formula  $n_1 = 1, n_2 = 2,3,4,5,\dots$

**BALMER SERIES:**

When an electron jumps from any of the higher states to the state with  $n=2$ , the series of spectral lines emitted lies in the **visible** region and are called as Balmer series.

Therefore, in Rydberg's formula  $n_1 = 2, n_2 = 3,4,5,6,\dots$

## STRUCTURE OF ATOM

### PASCHEN SERIES :

When an electron jumps from any of the higher states to the state with  $n=3$ , the series of spectral lines emitted lies in the **infrared** region and are called as Paschen series.

Therefore, in Rydberg's formula  $n_1 = 3, n_2 = 4, 5, 6, \dots$

### BRACKETT SERIES :

When an electron jumps from any of the higher states to the state with  $n = 4$ , the series of spectral lines emitted lies in the **infrared** region and are called as Brackett series.

Therefore, in Rydberg's formula  $n_1 = 4, n_2 = 5, 6, 7, \dots$

### PFUND SERIES :

When an electron jumps from any of the higher states to the state with  $n = 5$ , the series of spectral lines emitted lies in the **infrared** region and are called as Pfund series.

Therefore, in Rydberg's formula  $n_1 = 5, n_2 = 6, 7, \dots$

#### 10.5 Ionisation Energy

It is the energy required to remove the electron completely from the atom so as to convert it into a positive ion.

Thus,  $n_1 = 1$  and  $n_2 = \infty$

#### 10.6 Limiting Line

It is the line of shortest wavelength i.e.  $n_2 = \infty$



Although a hydrogen atom has only one electron, yet its spectra contains large number of lines. This is because a sample of hydrogen gas contains large number of molecules. When such a sample is heated to a high temperature, the hydrogen molecules split into hydrogen atoms. The electrons in different hydrogen atoms absorb different amounts of energies and are excited to different levels. When these electrons return, different electrons adopt different routes to return to the ground state. Thus, they emit different amounts of energies and thus large number of lines in atomic spectra in hydrogen.

Maximum no. of lines that can be emitted when an electron in an excited state  $n_2$  de-excites to  $n_1$  ( $n_2 > n_1$ ):

$$\frac{(n_2 - n_1 + 1)(n_2 - n_1)}{2}$$

#### 10.7 Limitations of Bohr's Model

- 1) Inability to explain line spectra of multi-electron atoms.
- 2) It fails to account for the finer details (doublet-two closely spaced lines) of the hydrogen spectra.

- 3) Inability to explain splitting of lines in the magnetic field (Zeeman Effect) and in the electric field (Stark Effect)- If the source emitting the radiation is placed in magnetic or electric field, it is observed that each spectral line splits up into a number of lines. Splitting of spectral lines in magnetic field is known as Zeeman Effect while splitting of spectral lines in electric field is known as Stark Effect.
- 4) It could not explain the ability of atoms to form molecules by covalent bonds.
- 5) He ignores dual behaviour of matter and also contradicts Heisenberg uncertainty principle.

## 11. TOWARDS QUANTUM MECHANICAL MODEL

This model was based on two concepts:

- (1) de Broglie Concept of dual nature of matter
- (2) Heisenberg uncertainty Principle

### 11.1 Dual behaviour of matter

de Broglie proposed that matter should also exhibit dual behaviour i.e. both particle and wave like properties.

$$\lambda = \frac{h}{mv} = \frac{h}{p} = \frac{h}{\sqrt{2m(\text{KE})}} = \frac{h}{\sqrt{2mqV}}$$

Where  $p$  is linear momentum of a particle.

According to de Broglie, every object in motion has a wave character. The wavelengths associated with ordinary objects are so short (because of their large masses) that their wave properties cannot be detected. The wavelengths associated with electrons and other subatomic particles (with very small mass) can however be detected experimentally.

### 11.2 Heisenberg's Uncertainty Principle

It is impossible to measure simultaneously the position and momentum of a small particle with absolute accuracy. If an attempt is made to measure any of these two quantities with higher accuracy, the other becomes less accurate. The product of the uncertainty in the position ( $\Delta x$ ) and the uncertainty in momentum ( $\Delta p$ ) is always a constant and is equal to or greater than  $h/4\pi$ .

$$(\Delta x) \cdot (\Delta p) \geq h/4\pi$$

$$\text{Or } (\Delta x) \cdot (m\Delta v) \geq h/4\pi$$

$$\text{Or } (\Delta x) \cdot (\Delta x) \geq h/4\pi m$$

### 11.2.1 Explanation

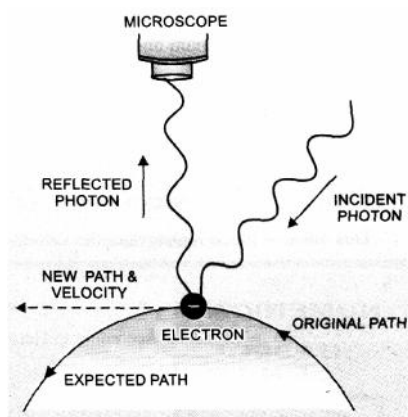

#### Change of momentum and position of electron on impact with a photon

Suppose we attempt to measure both the position and momentum of an electron. To pin point the position of the electron we have to use light so that the photon of light strikes the electron and the reflected photon is seen in the microscope. As a result of the hitting, the position as well as the velocity of the electron are disturbed.

### 11.2.2 Significance of Uncertainty Principle:

It rules out the existence of definite paths or trajectories of electrons as stated in Bohr's Model.



The effect of Heisenberg Uncertainty Principle is significant only for motion of microscopic objects, and is negligible for that of macroscopic objects.

## 12. QUANTUM MECHANICAL MODEL OF ATOM

Quantum mechanics is a theoretical science that deals with the study of the motion of microscopic objects which have both particle like and wave like properties. The fundamental equation of quantum mechanics was developed by Schrodinger.

This equation describes a function called **electron wave function** ( $\Psi$ ). This wave function stores all the information about an electron like energy, position, orbital etc. As such it does not have any physical significance. The information stored in  $\Psi$  about an electron can be extracted in terms of **Quantum Numbers**.

### 12.1 Probability Density

$|\Psi|^2$  is the probability of finding the electron at a point within an atom.

### 12.2 Concept of Orbital

It is a three dimensional space around the nucleus within which the probability of finding an electron of given energy is maximum (say upto 90%).

### 12.3 Quantum Numbers

They may be defined as a set of four numbers with the help of which we can get complete information about all the electrons in an atom i.e. location, energy, type of orbital occupied, shape and orientation of that orbital etc.

The three quantum numbers called as Principal, Azimuthal and Magnetic quantum number are derived from Schrodinger wave equation. The fourth quantum number i.e. the Spin quantum number was proposed later on.

#### 1) Principal Quantum Number (n):

It tells about the **shell** to which an electron belongs.

$n = 1, 2, 3, 4, 5, \dots$  and so on.

This number helps to explain the **main lines of the spectrum** on the basis of electronic jumps between these shells.

- It gives the **average distance** of the electron from the nucleus. Larger the value of  $n$ , larger is the distance from the nucleus.
- It completely determines the **energy** in hydrogen atom or hydrogen like species.

The energy of H-atom or H-like species depends only on the value of  $n$ .

**Order of energy** :  $1 < 2 < 3 < 4 < 5, \dots$  and so on.

For multi-electron species, energy depends on both principal and azimuthal quantum number.

The maximum number of electrons present in any shell =  $2n^2$

#### 2) Azimuthal Quantum Number (l):

Also known as **Orbital Angular momentum** or **Subsidiary quantum number**. Within the same shell, there are number of sub-shells, so number of electronic jumps increases and this explains the presence of fine lines in the spectrum. This quantum number tells about :

- The number of **subshells** present in a shell.
- Angular momentum of an electron present in subshell.



## STRUCTURE OF ATOM

(c) **Shapes** of various subshells present within the same shell.

(d) Relative energies of various subshells.

Value of  $l$  varies from 0 to  $n - 1$

For 1<sup>st</sup> shell ( $n = 1$ ):  $l = 0$

For 2<sup>nd</sup> shell ( $n = 2$ ):  $l = 0, 1$

For 3<sup>rd</sup> shell ( $n = 3$ ):  $l = 0, 1, 2$

For 4<sup>th</sup> shell ( $n = 4$ ):  $l = 0, 1, 2, 3$

Value of $l$	Designation of subshell
0	s
1	p
2	d
3	f
4	g
5	h

The notations s, p, d, f represent the initial letters of the word sharp, principal, diffused and fundamental. In continuation  $l = 4$  is called g subshell and  $l = 5$  is called h subshell and so on.

Principal shell	Subshells
1 <sup>st</sup> shell	$l = 0$ (s-subshell)
2 <sup>nd</sup> shell	$l = 0, 1$ (s & p subshell)
3 <sup>rd</sup> shell	$l = 0, 1, 2$ (s, p & d subshell)
4 <sup>th</sup> shell	$l = 0, 1, 2, 3$ (s, p, d & f subshell)



The number of subshells present in any principal shell is equal to the number of the principal shell.

Energies of various subshell present within the same shell

is:  $s < p < d < f$

Angular momentum of an electron in orbital :

$$\frac{h}{2\pi} \sqrt{l(l+1)} = \hbar \sqrt{l(l+1)}$$

(3) **Magnetic Quantum Number(m):**

This quantum number is required to explain the fact that when the source producing the line spectrum is placed in a magnetic field, each spectral line splits up into a number of line (Zeeman effect).

Under the influence of external magnetic field, electrons of a subshell can orient themselves in a certain preferred regions of space around the nucleus called orbitals.

The magnetic quantum number determines the number of preferred orientations of the electrons present in a subshell. Since each orientation corresponds to an orbital, thus magnetic quantum number determines the **number of orbitals** present in any subshell.

Value of  $m$  ranges from  $-l$  to  $+l$  including zero.

Sub-shell	Orbitals (m)	Number of orbitals
s-subshell ( $l=0$ )	$m = 0$	1
p-subshell ( $l=1$ )	$m = -1, 0, 1$	3
d-subshell ( $l=2$ )	$m = -2, -1, 0, 1, 2$	5
f-subshell ( $l=3$ )	$m = -3, -2, -1, 0, 1, 2, 3$	7

Orbital	Value of $m$
$P_x$	$m = 0$
$P_y$	$m = +1$
$P_z$	$m = -1$

Orbital	Value of $m$
$d_{z^2}$	$m = 0$
$d_{xz}$	$m = +1$
$d_{yz}$	$m = -1$
$d_{x^2-y^2}$	$m = +2$
$d_{xy}$	$m = -2$

These orbitals of the same subshell having equal energy are called **degenerate orbitals**. Eg.

The three p-orbitals of a particular principal shell have the same energy in the absence of magnetic field.

Similarly, all five orbitals of d-subshell of a particular shell have the same energy.

**Thus, for H-atom order of energy is:**

$$1s < 2s = 2p < 3s = 3p = 3d < 4s = 4p = 4d = 4f < \dots\dots\dots$$

For multi electron atoms, the energy of the orbitals decreases with increase in effective nuclear charge. Eg

$$E_{2s}(\text{H}) > E_{2s}(\text{Li}) > E_{2s}(\text{Na}) > E_{2s}(\text{K})$$

**The total possible values of m in a given subshell =  $2l + 1$**

**Total no. of orbitals in a given shell =  $n^2$**

#### 4) Spin Quantum Number(s):

The electron in an atom not only moves around the nucleus but also spins about its own axis. Since the electron in an orbital can spin either in clockwise or anti-clockwise direction. Thus s can have only two values

$$+\frac{1}{2} \text{ or } -\frac{1}{2}$$

This quantum number helps to explain the magnetic properties of substances.



An orbital cannot have more than two electrons and these electrons should be of opposite spin.

Thus, maximum number of electrons in s-subshell = 2

Maximum number of electrons in p-subshell = 6

Maximum number of electrons in d-subshell = 10

Maximum number of electrons in f-subshell = 14

### 12.4 Shapes of atomic orbitals

#### (1) Shape of s-orbitals:

- They are non-directional and spherically symmetric i.e. probability of finding the electron at a given distance is equal in all directions.
- 1s orbital and 2s orbital have same shape but size of 2s is larger.
- There is a spherical shell within 2s orbital where electron density is zero and is called a node.

- The value of azimuthal quantum number ( $l$ ) is zero ( $l=0$ ) and magnetic quantum number can have only one value i.e.  $m=0$

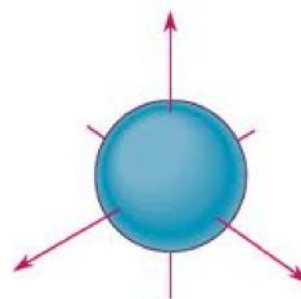

#### (2) Shape of p-orbitals:

- It consists of two lobes present on either side of the plane that passes through the nucleus. The p-orbital is dumb-bell shaped.
- There are three possible orientations of electron cloud in p-orbitals. Therefore, the lobes of p-orbital may be considered to be along x, y and z axis. Hence they are designated as  $p_x, p_y, p_z$ . The three p-orbitals are oriented at right angles to one another.
- First main energy level (Principal quantum number  $n = 1$ ) does not contain any p-orbital.
- The three p-orbitals of a particular energy level have same energy in absence of an external electric and magnetic field and are called degenerate orbitals.
- Like s orbitals, p-orbitals increase in size with increase in the energy of main shell of an atom. Thus, value of azimuthal quantum number is one ( $l=1$ ) and magnetic quantum number has three values ( $m = -1, 0, +1$ )

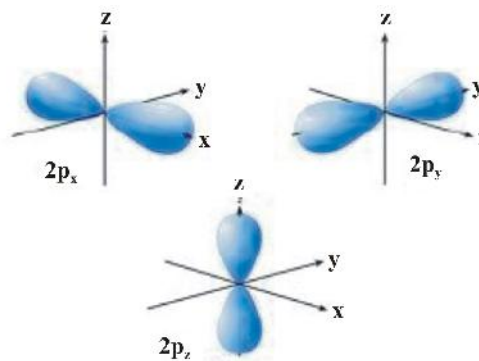

## STRUCTURE OF ATOM

### (3) Shapes of d-orbitals:

- (a) They are designated as  $d_{xy}$ ,  $d_{yz}$ ,  $d_{zx}$  and  $d_{x^2-y^2}$ . They have a shape like a four leaf clover. The fifth d orbital designated as  $d_{z^2}$  looks like a doughnut.
- (b) All five d orbitals have same energy in the absence of magnetic field.
- (c) .....  $l = 2$  and magnetic quantum number values  $-2, -1, 0, +1, +2$ .
- (d) For principal shell number 1 and 2, there are no d orbitals.

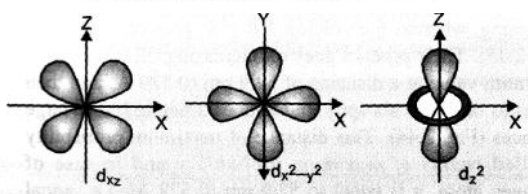
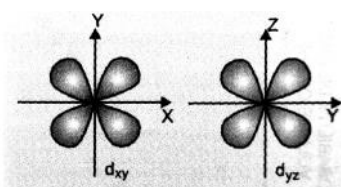

We have drawn boundary surface diagrams i.e the surface is drawn in space for an orbital on which probability density  $(\psi)^2$  is constant. It encloses the region where probability of finding the electron is very high. We do not draw a boundary surface diagram that encloses 100% probability of finding the electron because probability density has some value, however small it may be, at any finite distance from the nucleus. Thus it is not possible to draw a boundary surface diagram of a rigid size in which the probability of finding the electron is 100%.

### 12.5 Nodes and nodal planes

#### Node:

It is a region of zero probability.

There are two types of nodes:

- (1) **Radial or Spherical nodes:** Three dimensional regions in an orbital where probability of finding the electron becomes zero.

Number of radial/ spherical nodes =  $n - l - 1$

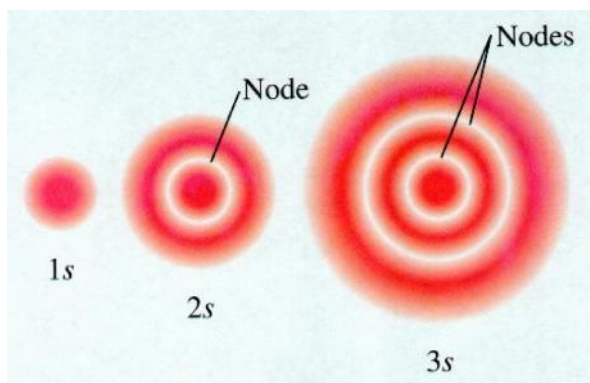

- (2) **Planar or Angular Nodes:** They are the planes cutting through the nucleus on which probability of finding the electron is zero.

Number of Planar/Angular Nodes:  $l$

Total Number of nodes:  $n - 1$

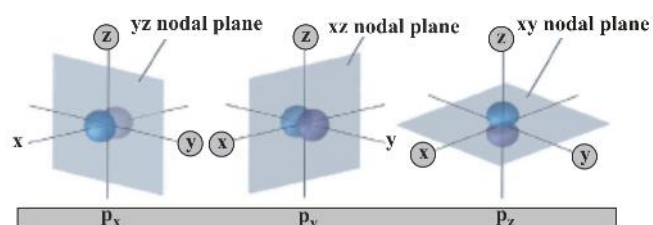

### 12.6 Filling of orbitals in an atom

- (1) **Aufbau Principle:**

In the ground state of the atoms, the orbitals are filled in order of their increasing energies. In other words, electrons first occupy the lowest energy orbital available to them and enter into higher energy orbitals only when the lower energy orbitals are filled.

Unlike H-atom where energy of orbitals depend only on  $n$ , energy of orbitals of multi-electron orbitals depend on both  $n$  and  $l$ . Their order of energy can be determined using **(n+l) rule**.

According to this rule, lower the value of  $(n+l)$  for an orbital, lower is its energy. If two different types of orbitals have the same value of  $(n+l)$ , the orbital with lower value of  $n$  has lower energy.

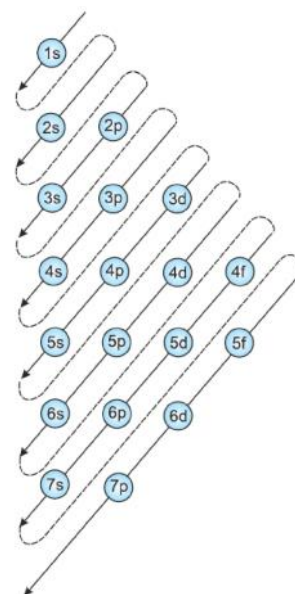

$1s^2 2s^2 2p^6 3s^2 3p^6 4s^2 3d^{10} 4p^6 5s^2 4d^{10} 5p^6 6s^2 \dots$

(2) **Pauli Exclusion Principle:** An orbital can have maximum two electrons and these must have opposite spin.

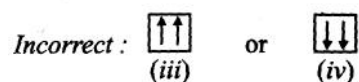
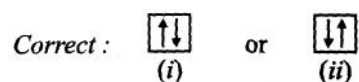

(3) **Hund's rule of maximum multiplicity:** Electron pairing in p, d and f orbitals cannot occur until each orbital of a given subshell contains one electron each. Also all the singly occupied orbitals will have **parallel spin**.

**Electronic configurations of elements in the ground state**

Atomic No.	Element	Electronic Config
1	H	$1s^1$
2	He	$1s^2$
3	Li	$[\text{He}] 2s^1$
4	Be	$[\text{He}] 2s^2$
5	B	$[\text{He}] 2s^2 2p^1$
6	C	$[\text{He}] 2s^2 2p^2$
7	N	$[\text{He}] 2s^2 2p^3$
8	O	$[\text{He}] 2s^2 2p^4$
9	F	$[\text{He}] 2s^2 2p^5$
10	Ne	$[\text{He}] 2s^2 2p^6$
11	Na	$[\text{Ne}] 3s^1$
12	Mg	$[\text{Ne}] 3s^2$
13	Al	$[\text{Ne}] 3s^2 3p^1$
14	Si	$[\text{Ne}] 3s^2 3p^2$
15	P	$[\text{Ne}] 3s^2 3p^3$
16	S	$[\text{Ne}] 3s^2 3p^4$
17	Cl	$[\text{Ne}] 3s^2 3p^5$
18	Ar	$[\text{Ne}] 3s^2 3p^6$
19	K	$[\text{Ar}] 4s^1$
20	Ca	$[\text{Ar}] 4s^2$
21	Sc	$[\text{Ar}] 3d^1 4s^2$
22	Ti	$[\text{Ar}] 3d^2 4s^2$
23	V	$[\text{Ar}] 3d^3 4s^2$

## STRUCTURE OF ATOM

24	Cr	$[\text{Ar}] 3d^5 4s^1$
25	Mn	$[\text{Ar}] 3d^5 4s^2$
26	Fe	$[\text{Ar}] 3d^6 4s^2$
27	Co	$[\text{Ar}] 3d^7 4s^2$
28	Ni	$[\text{Ar}] 3d^8 4s^2$
29	Cu	$[\text{Ar}] 3d^{10} 4s^1$
30	Zn	$[\text{Ar}] 3d^{10} 4s^2$

### 12.7 Exceptional Configuration of Cr & Cu

The completely filled and completely half filled subshells are stable due to the following reasons:

- Symmetrical distribution of electrons:** It is well known that symmetry leads to stability. The completely filled or half filled subshells have symmetrical distribution of electrons in them and are therefore more stable. Electrons in the same subshell (here  $3d$ ) have equal energy but different spatial distribution. Consequently, their shielding of one another is relatively small and the electrons are more strongly attracted by the nucleus.
- Exchange Energy :** The stabilizing effect arises whenever two or more electrons with the same spin are present in the degenerate orbitals of a subshell. These electrons tend to exchange their positions and the energy released due to this exchange is called exchange energy. The number of exchanges that can take place is maximum when the subshell is either half filled or completely filled. As a result the exchange energy is maximum and so is the stability.

eg. for Cr :  $[\text{Ar}] 4s^1 3d^5$

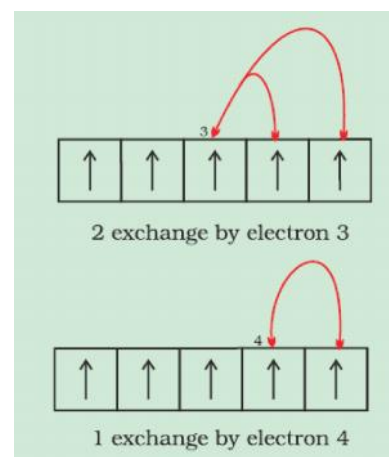
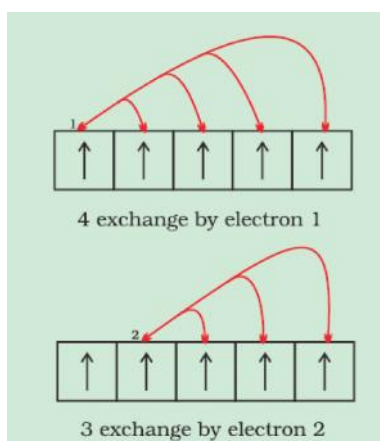

Thus, total number of exchanges = 10

### 12.8 Electronic Configuration of Ions

#### 12.8.1 Cations:

They are formed when outermost electrons are removed from an atom. While removing the electrons, we must remove the electrons from the highest principal quantum number.

#### 12.8.2 Anions:

They are formed when electrons are added to the innermost empty shell.

#### 12.8.3 Magnetic moment :

$$\sqrt{n(n+2)} \text{ B.M.}$$

B.M. → Bohr Magneton

Where  $n$  is number of unpaired electrons.

Species with unpaired electrons are called **paramagnetic** and the species with no unpaired electrons are called **diamagnetic**

## 13. IMPORTANT RELATIONS

$$\text{Rydberg equation : } \frac{1}{\lambda} = R_H \left( \frac{1}{n_1^2} - \frac{1}{n_2^2} \right)$$

$$(R_H = 109678 \text{ cm}^{-1} \text{ and } n_2 > n_1)$$

$$c = \lambda \times \nu \text{ and } \bar{\nu} = \frac{1}{\lambda}$$

$$E = h\nu \text{ or } = \frac{hc}{\lambda}$$

## Bohr's Model

$$E_n = \frac{-1312Z^2}{n^2} \text{ kJ mol}^{-1}$$

$$= \frac{-2.178 \times 10^{-18} Z^2}{n^2} \text{ J/atom} = \frac{-13.6Z^2}{n^2} \text{ eV/atom}$$

$$\text{Velocity of electron, } v_n = \frac{2.165 \times 10^6 Z}{n} \text{ m/s}$$

$$\text{Radius of orbit} = \frac{0.529 n^2}{Z} \text{ \AA}$$

$$\text{Photoelectric effect} = h\nu = h\nu_0 + \frac{1}{2}mv^2$$

$$(v_0 = \text{Threshold frequency})$$

$$\text{de-Broglie equation : } \lambda = \frac{h}{mv}$$

$$\text{Heisenberg's uncertainty principle : } \Delta x \times \Delta p \geq \frac{h}{4\pi}$$

## 14. MATHEMATICAL MODELLING OF BOHR'S POSTULATES

Consider an ion of atomic number (Z) containing single electron revolving its nucleus at a distance of 'r' as shown in the figure.

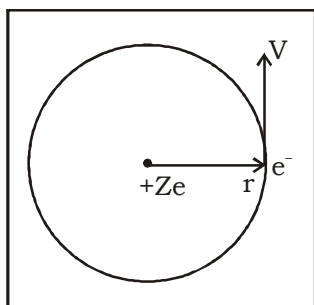

Note...

Atomic number = Number of protons on the nucleus = Z

⇒ Charge on the nucleus = + Ze

Electrostatic force of attraction (F) between the nucleus of charge + Ze and electron (-e) is given by :

$$F = \frac{K |q_1| |q_2|}{r^2} \quad \text{where } K = \frac{1}{4\pi\epsilon_0}$$

$$= 9 \times 10^9 \text{ Nm}^2\text{C}^{-2}$$

$$F = \frac{K |Ze| |-e|}{r^2} = \frac{KZe^2}{r^2} \quad \dots\dots(i)$$

The centrifugal forces acting on the electron is  $\frac{mv^2}{r}$  .....(ii)

This centrifugal force must be provided by the electrostatic force of attraction (F).

⇒ From (i) and (ii), we have :

$$\frac{KZe^2}{r^2} = \frac{mv^2}{r} \quad \dots\dots(iii)$$

Angular momentum of electron about the nucleus =

$$mVr = \frac{nh}{2\pi} \quad \dots\dots(iv)$$

where 'n' is a positive integer

(n = 1, 2, 3, ..... ∞)

Solve (iii) and (iv) to get :

$$v = \frac{2\pi KZe^2}{nh} \text{ and } r = \frac{n^2 h^2}{4\pi^2 Kme^2 Z}$$

put  $K = 9 \times 10^9 \text{ Nm}^2\text{C}^{-2}$ ,  $e = 1.6 \times 10^{-19} \text{ C}$  and  $h = 6.63 \times 10^{-34} \text{ Js}$  in the above expressions to get :

**Velocity of an electron in n<sup>th</sup> Bohr orbit  $\hat{0}$**

$$V_n = 2.165 \times 10^6 \frac{Z}{n} \text{ ms}^{-1}$$

**and Radius of the n<sup>th</sup> Bohr orbit  $\hat{0}$   $r_n = 0.53 \frac{n^2}{Z} \text{ \AA}$**

Now, the Total Energy of the electron moving in n<sup>th</sup> orbit = K.E.<sub>n</sub> + E.P.E.<sub>n</sub>

$$T.E._n = \frac{1}{2} mV_n^2 + \frac{K(Ze)(-e)}{r} \quad \left[ \because \text{E.P.E.} = \frac{K q_1 q_2}{r} \right]$$

## STRUCTURE OF ATOM

$$\Rightarrow T.E_n = \frac{1}{2} \left( \frac{KZe^2}{r_n} \right) + \frac{K(Ze)(-e)}{r_n} \quad [\text{Using (iii)}]$$

$$\Rightarrow E_n \equiv T.E_n = \frac{-KZe^2}{2r_n}$$

It can be shown from the above expressions that :

$$K.E_n = \frac{1}{2} \frac{KZe^2}{r_n}, P.E_n = \frac{-KZe^2}{r_n} \text{ and } E_n = \frac{-KZe^2}{2r_n}$$

$$\text{or } K.E_n = -E_n \text{ and } P.E_n = 2E_n$$

Using the value of  $r_n$  in the expression of  $E_n$ , we get :

$$E_n = \frac{-2\pi^2 K^2 m e^4 Z^2}{n^2 h^2}$$

$$E_n \equiv -2.178 \times 10^{-18} \frac{Z^2}{n^2} \text{ J/atom}$$

$$\text{or } E_n \equiv -13.6 \frac{Z^2}{n^2} \text{ eV/atom}$$

$$[\because 1\text{eV} = 1.6 \times 10^{-19} \text{ J}]$$

$$\equiv -2.178 \times 10^{-18} \frac{Z^2}{n^2} \times 6.02 \times 10^{23} \text{ J/mole}$$

$$\hat{=} -1312 \frac{Z^2}{n^2} \text{ kJ/mole}$$

## 15. PROBABILITY DISTRIBUTION DIAGRAMS FOR 1s AND 2s

