



# पुर्ना International School

Shree Swaminarayan Gurukul, Zundal

SUMMATIVE ASSIGNMENT -II 2023-24

Grade – Jr..KG

Syllabus - FROM TEXTBOOK

Subject- EVS

## 1. Myself

1. My name is \_\_\_\_\_.
2. I am a \_\_\_\_\_. (boy / girl)
3. I study in Sr.KG.
4. I am \_\_\_\_\_ years old.
5. My school name is P.I.S Gurukul.

## 2. Label the indication of traffic light and colour the picture.

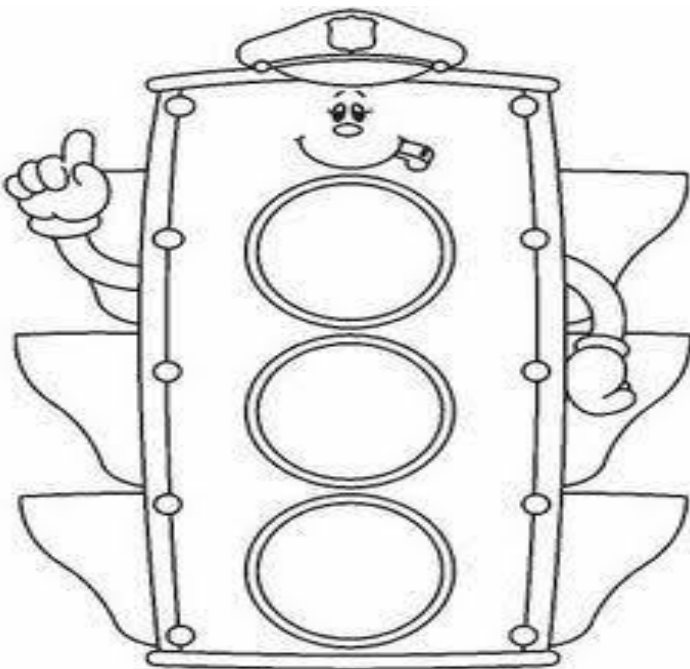

Red says Stop

Yellow says Go slow

Green says Go



5. Circle the things that we see in rainy season.



6. Fill in the blanks.

Fill in the blanks with the help of suitable pictures from below :

1. The doctor gives us medicines.
2. We drop our letters in the Letter box
3. The Farmer grows crops for us.
4. A Barber uses 
5. The Policeman catches thieves.



7. Write the names of the helper who use these tools.



Barber



Cobbler

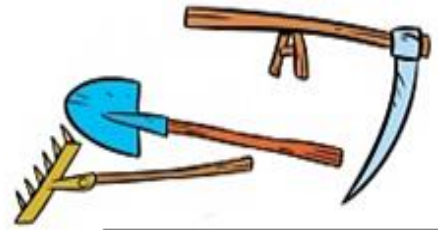

Farmer



Plumber

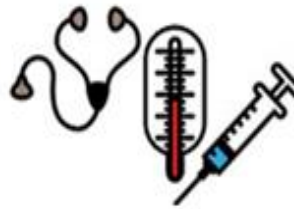

Doctor

8. Write the names of the national symbols.

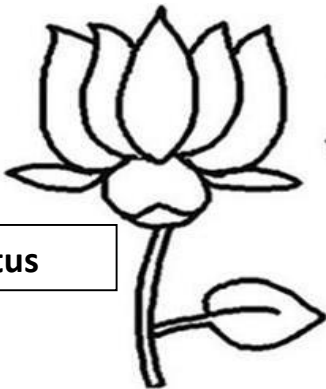

Lotus

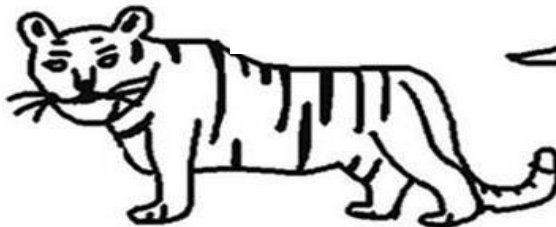

Tiger

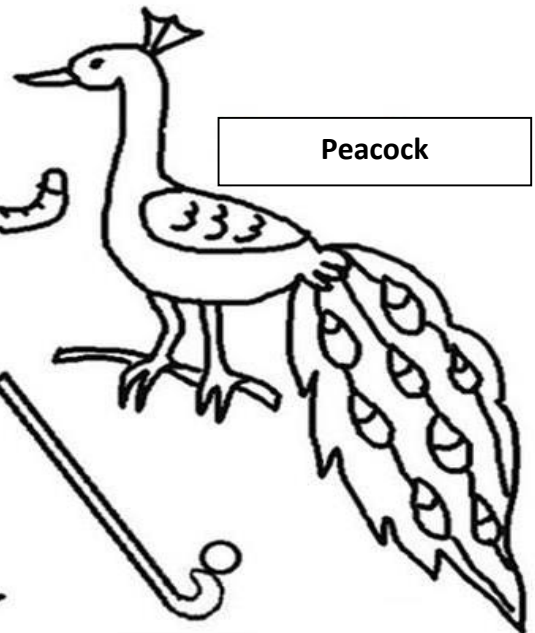

Peacock

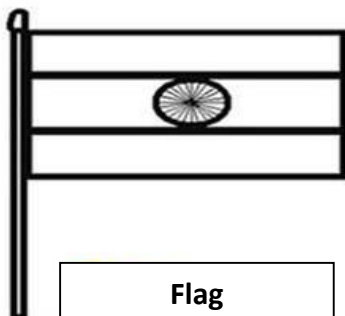

Flag

















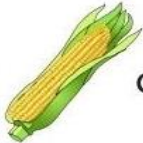

Mango



Hockey

**9. Fill in the missing letters of fruits and vegetables.**

 _ppl_	 b_n_n_	 c_bb_g_	 c_rr_t
 ch_rr_s	 gr_p_s	 c_rn	 c_c_mb_r
 _r_ng_	 p_ch	 _ggpl_nt	 l_tt_c_
 l_m_n	 p_r	 _n_n	 p_s

**10. Fill in the blanks.**

1. There are \_\_\_\_\_ planets in our solar system.
2. There are \_\_\_\_\_ days in a week.
3. There are \_\_\_\_\_ months in a year.
4. Name of our country is \_\_\_\_\_.
5. There are \_\_\_\_\_ colours in our National flag.
6. \_\_\_\_\_ is called the ' Festival of lights.'
7. \_\_\_\_\_ is the ' Festival of colours'.
8. Mahatma Gandhi is \_\_\_\_\_ of our Nation.



11. Choose the correct option and fill in the blank.

WORD BANK

moon sun day Earth clouds

a. The \_\_\_\_\_ shines during the \_\_\_\_\_.



b. The \_\_\_\_\_ goes around the sun.



c. Night occurs when the \_\_\_\_\_ and \_\_\_\_\_ covers the sun.



12. Write the flowers name.

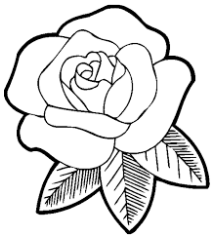

Rose



Lotus



Marigold

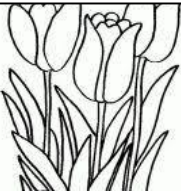

Tulip



Sunflower



Hibiscus

13. Look at the picture and fill the missing letters



Ba n k



AT M



Ra i l wa y S ta ti on



Te mp le

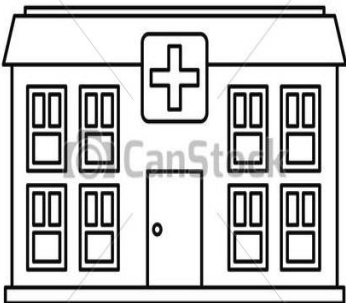

Ho sp i ta l



Sh oo l

#### 14. My school

1. My school name is P.I.S.
2. It has big campus.
3. It has 79 classes.
4. My principal name is Sadhana ma'am.
5. My teacher name is \_\_\_\_\_.
6. I love my school.

#### 15. Fill in the blanks.

1. When you are asking for something, say please.
2. When you hurt someone, say sorry.
3. When you are given something, say thank you.
4. When you interrupt someone, say excuse me.

#### 16 . Color the picture of a water cycle

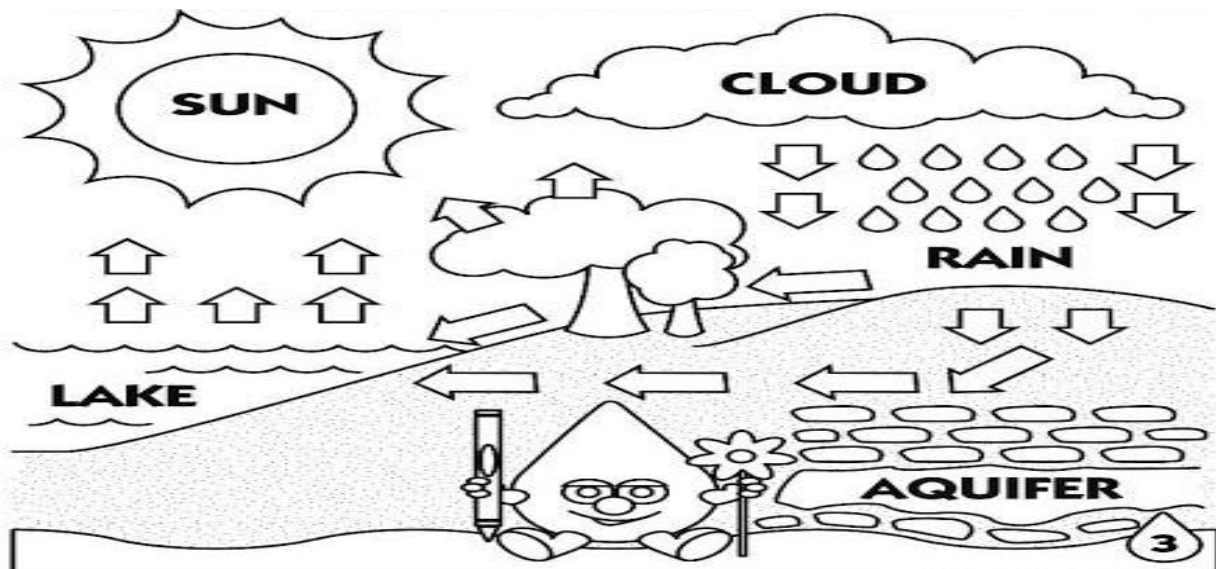



17. Look at picture and fill in the missing letters.

s ..... re ..... m



r ..... v ..... r



w ..... ll



l ..... k .....



r ..... i .....



t ..... p

