



पुर्णमा International School

Shree Swaminarayan Gurukul, Zundal

PERIODIC ASSIGNMENT – 1 2023 -24

Student's Name		Date			
Subject	English	Grade	Jr.KG	Roll No.	

Q.1 Write the missing capital alphabets (A to G).

A

G

G

Q.2 Match the letters with the correct picture.

A.

B.

C.

D.



Q.3 Write the before alphabets of the following.

_____ B _____ G

_____ D _____ C

_____ F _____ E

Q.4 Write the after alphabets of the following.

A _____ F _____

C _____ B _____

E _____ D _____

Q.5 Match the capital alphabet with the small alphabet.

A

e

B

g

C

a

D

b

E

c

F

d

G

f

Q .6 Circle the lower case letter matching with the upper case letter in Each row.

A	b	C	a
B	e	B	f
C	c	H	g
D	a	B	d
E	a	C	e
F	f	G	b
G	b	H	g

Q.7 Look at the picture and write the first letter.

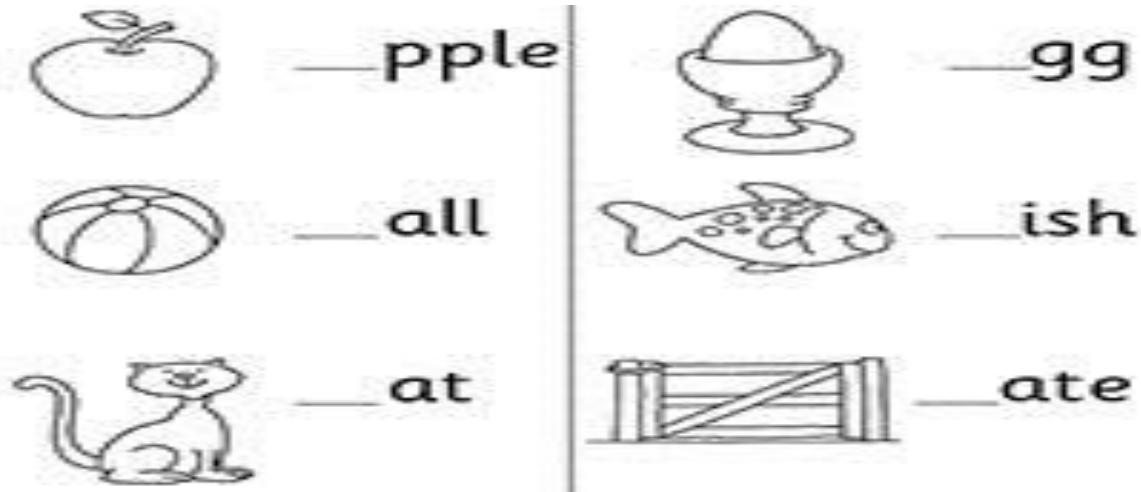

Q.8 Look at the picture and circle the correct letter

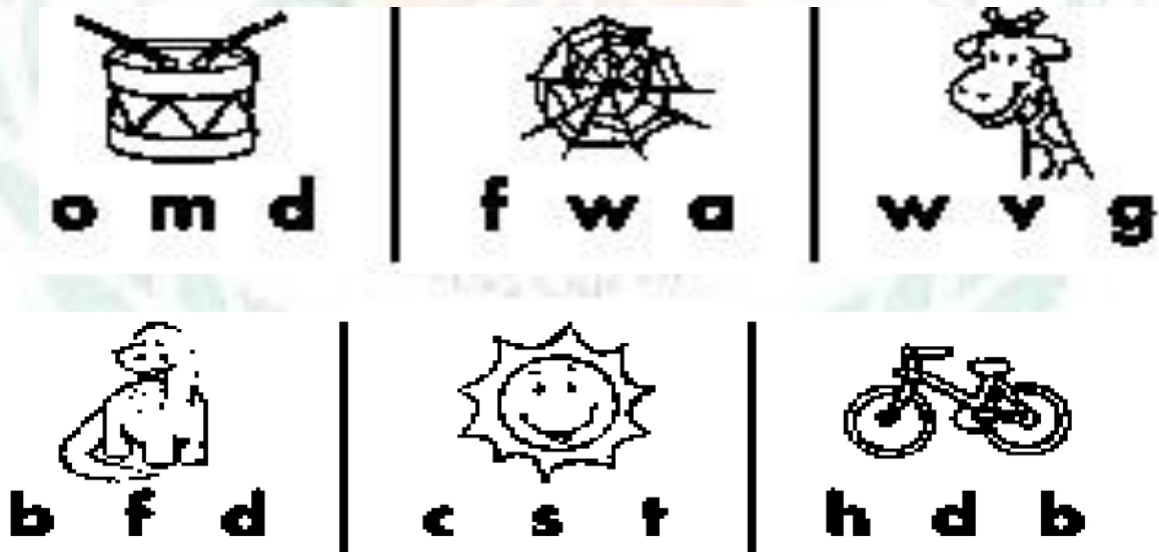





PERIODIC ASSIGNMENT -1 2023-24	
Grade – Jr.KG	Subject -EVS
Syllabus	From Textbook

Q 1: Match the Sense Organs with pictures.



Q 2: Match the body parts.

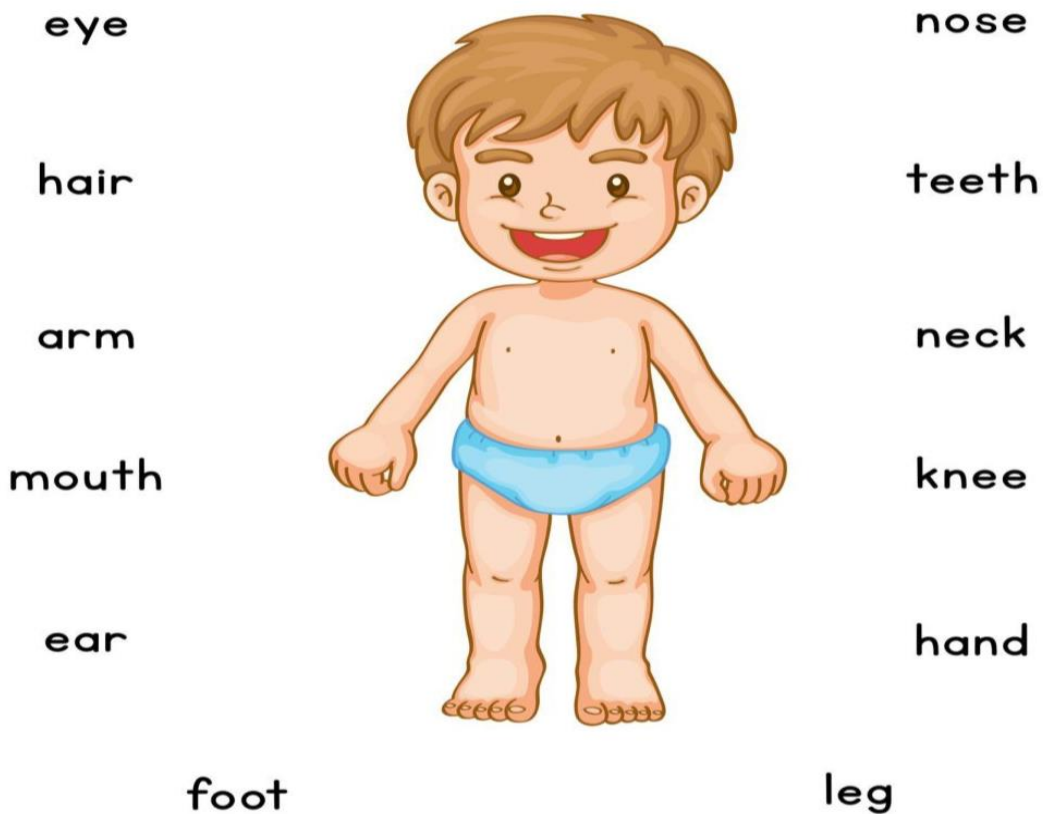

Q3: Match the Family Member.



Q 4: Circle the things which you will carry in your school bag.



Q5: How Many Body Parts I have?

- | | | | |
|--------|--------------------------|-----------------------------------------------------------------------------------|---------|
| I have | <input type="checkbox"/> |  | eyes |
| I have | <input type="checkbox"/> |  | mouth |
| I have | <input type="checkbox"/> |  | ears |
| I have | <input type="checkbox"/> |  | fingers |
| I have | <input type="checkbox"/> |  | legs |
| I have | <input type="checkbox"/> |  | arms |
| I have | <input type="checkbox"/> |  | toes |
| I have | <input type="checkbox"/> |  | nose |

1 2 3 4 5 6 7 8 9 10

Q 6: Circle the Animals.



Q 7: Fill in the missing first letters.



_oor



_ate



_ow



_ion



_ag



_hair

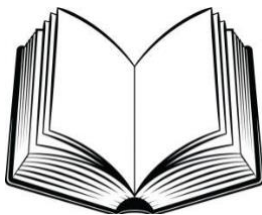

_ook



_encil

Q 8: Color the picture of a boy if you are a boy and if you are girl color the picture of the girl.

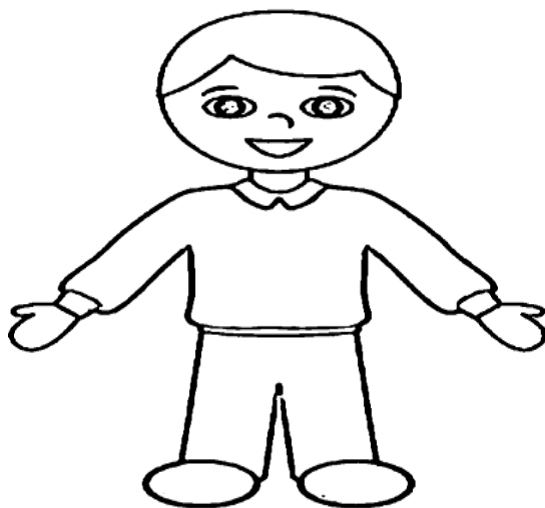



PERIODIC ASSIGNMENT -I [2023- 24]

GRADE – JR. KG.

SUBJECT - MATH

Syllabus – FROM TEXTBOOK

Q. 1 Write the missing numbers 1 to 10.

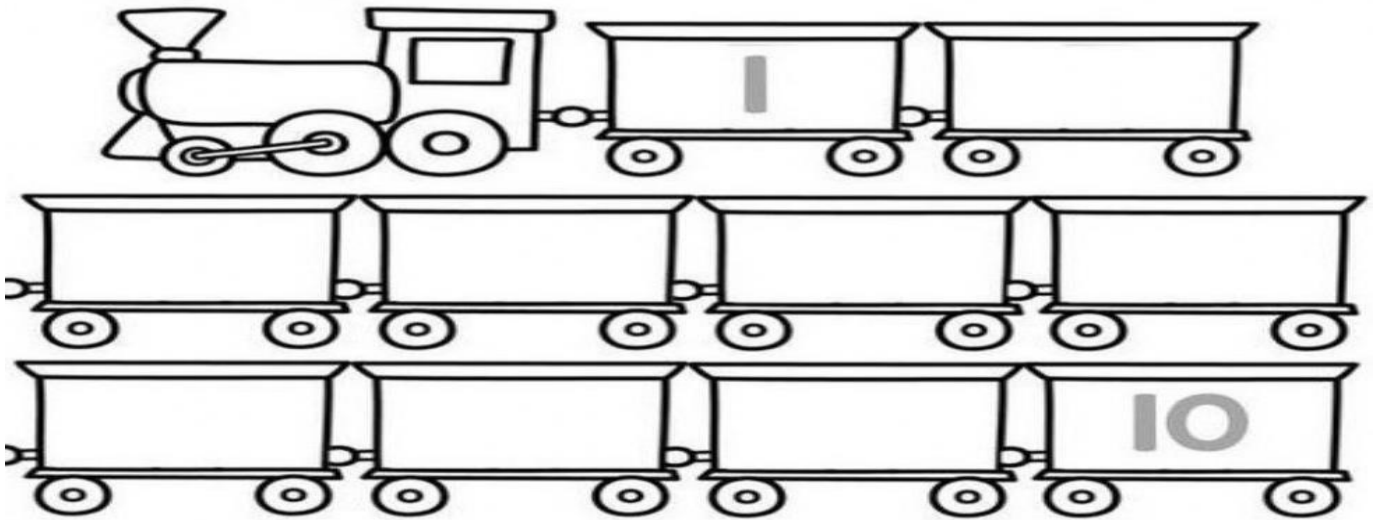

Q2: Count the dots and match with the correct number

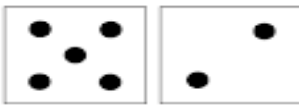

9

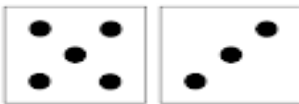

4

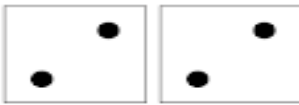

3

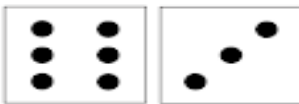

7



5











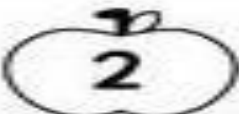
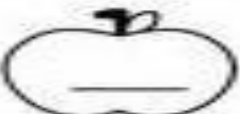

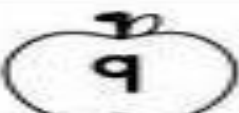
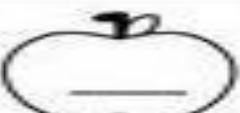

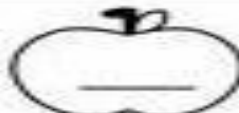
8

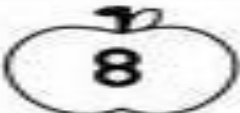



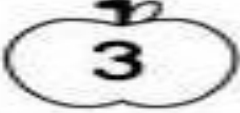





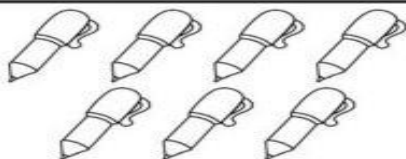







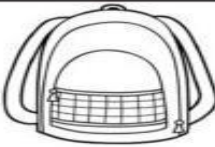

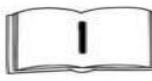



Q. 3 write the number names 1 to 5.

1 – One			
2 – Two			
3 – Three			
4 – Four			
5 – Five			

Q. 4 write the after number.

 2		 6	
 9		 4	
 1		 8	
 5		 3	

Q 5: Count and circle the correct number

  9  7  5	  12  6  4
  5  1  2	  10  8  3
  12  5  11	  4  3  5

Q 6: Color the Shapes and match them correctly

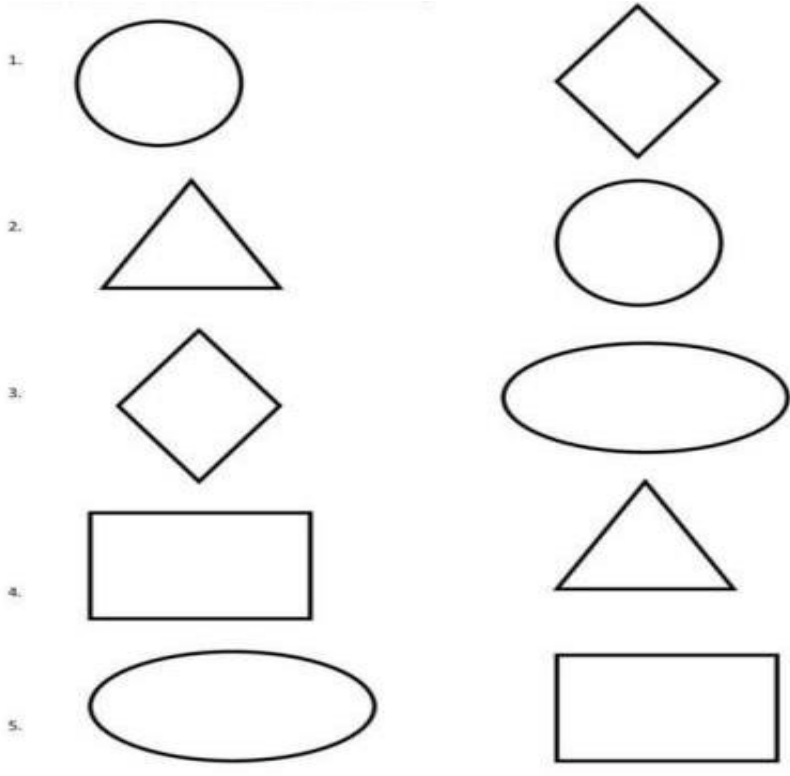

Q. 7 Join the dots and color the picture.

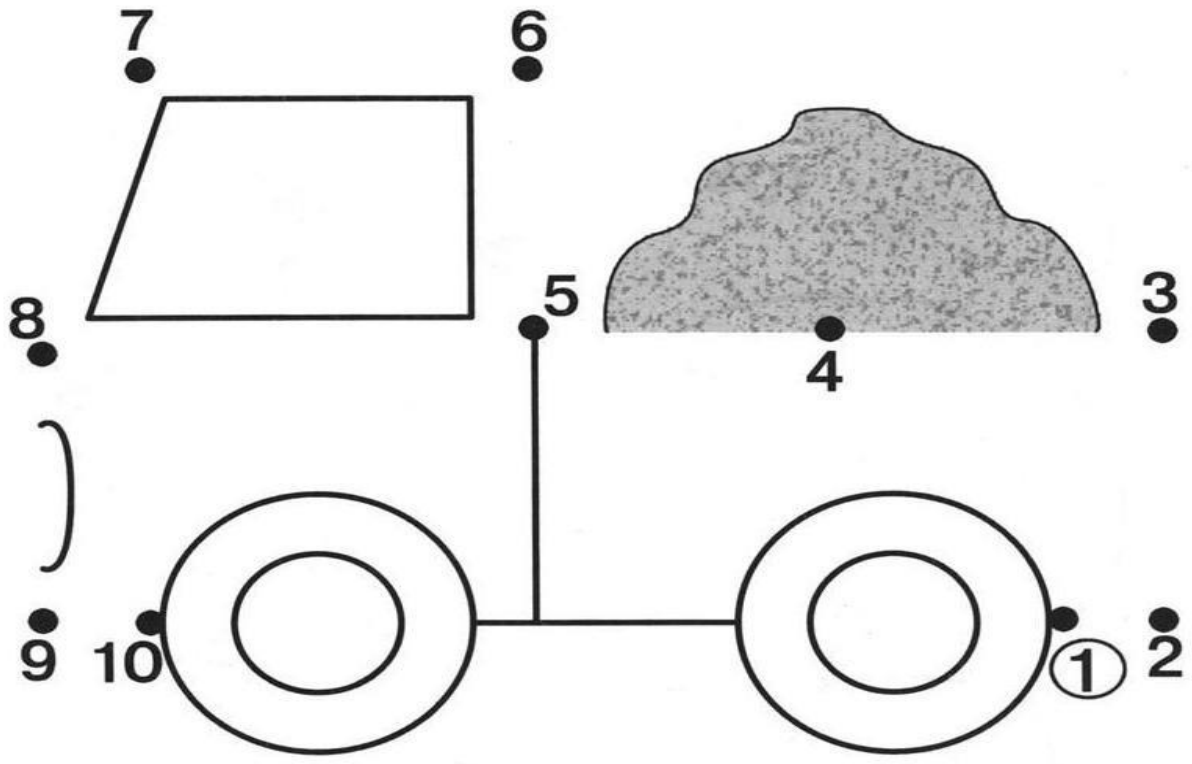



पुर्णा International School

Shree Swaminarayan Gurukul, Zundal

PERIODIC ASSIGNMENT -1 2023 - 24	
Grade – Jr.KG	Subject- Hindi
Syllabus - FROM TEXTBOOK	

प्रश्न १: अ से ऐ तक लिखो।

<input type="text"/>	<input type="text"/>	<input type="text"/>	<input type="text"/>
<input type="text"/>	<input type="text"/>	<input type="text"/>	<input type="text"/>
<input type="text"/>			

प्रश्न २: रिक्त स्थान भरो।

	आ		
		ऊ	

प्रश्न ३: चित्र देखकर सही अक्षर लिखो।



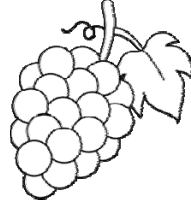



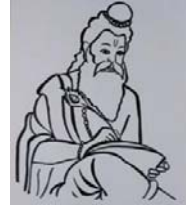

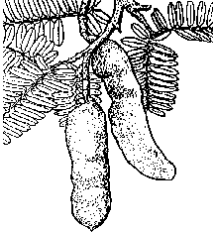









प्रश्न ४: स्वर को सही चित्र से मिलाओ ।

अ
औ
आ
ए
उ
अं
ए
ऊ



प्रश्न ५: अक्षर को अक्षर से मिलाओ।

अ

आ

इ

ई

उ

ऊ

ऋ

इ

ऋ

अ

उ

आ

ई

ऊ

प्रश्न ६: चित्र में रंग भरें।

